



2012

ENG



Paolo.  
His passion for  
cycling began long before  
getting onto the saddle.  
He just needs to browse  
through the pages  
of this catalogue.

## INDEX

2	PRO-TEAMS 2011
4	COMPONENTS TECHNOLOGY
28	VELOCE™
36	CENTAUR™
44	ATHENA™
52	CHORUS™
60	RECORD™
68	SUPER RECORD™
76	TT/TRIATHLON
82	CX™ COMPONENTS - WHEELS
100	PISTA™ COMPONENTS - WHEELS
102	WHEELS TECHNOLOGY
118	LOW-PROFILE WHEELS
128	MEDIUM-PROFILE WHEELS
148	ALU/CARBON HIGH-PROFILE WHEELS
166	CARBON HIGH-PROFILE WHEELS
178	TECHNICAL SPECIFICATIONS GROUPSETS
196	TECHNICAL SPECIFICATIONS WHEELS
212	CAMPAGNOLO® SERVICE CENTER
214	CAMPAGNOLO® SALES NETWORK





Francisco\*.  
He knows that in order to win  
you have to give your best  
until the end. He expects no less  
from his groupset.

\*Francisco Jose Ventoso







## PRO-TEAMS 2011

Exertion, sweat, breakaways and final sprints: they're all synonyms of passion, performance, and goals to be achieved.

And they're also the ingredients that make up the life of the pros whose passion has become their professional life, their dreams and goals.

Goals that can be achieved thanks to the commitment, effort, and determination that these champions demand of themselves and of those who supply them with the tools they need in order to compete and win.

The quest for excellence and victory is the daily challenge that links Campagnolo with the champions: when you've achieved one goal, there's always the next one.

Campagnolo 11-speed drivetrains are the banner that joins, accompanies, and in many cases mitigates the exertion and efforts of hosts of professionals as well as many non-professional enthusiasts.

2011 PRO-TEAMS	BICYCLE BRAND	COUNTRY TEAM
Lampre-ISD	Wilier Triestina	Italy
Team Colnago - CFS Inox	Colnago	Italy
Team De Rosa - Ceramica Flaminia	De Rosa	Italy
G.S. Nippo Feudi S. Marzano	Kyklos	Italy
Europcar	Colnago	France
Cofidis Competition	Look	France
Omega Pharma/Lotto	Canyon	Belgium
Quick Step	Eddy Merckx	Belgium
Topsport - Vlaanderen	Eddy Merckx	Belgium
Movistar	Pinarello	Spain
Aisan Racing Team	Wilier Triestina	Japan

## CAMPY TECH LAB

It's the pride and joy of our company, the beating heart that delivers the innovations and the innumerable patents that over the years have contributed to creating and preserving the Campagnolo® legend. Inside the **Campy Tech Lab™**, highly sophisticated products are designed, tested, and developed that embody the DNA of Campagnolo®, a company that in its almost 80 years of life has made bicycle history and finds its maximum expression and reason for existence in this container of experience, passion, and abnegation for innovation.

The **Campy Tech Lab™** is imbued with a culture of thinking projected into the future, constant analysis of what can be improved but above all what we really want to innovate.

Here, designing a drivetrain or a wheel means first and foremost sharing the concept of technology at the service of real people, where the design objective cannot be a single one but has to incorporate the right balance between equally important factors: performance, reliability, quality, design, and safety.

Safety is the common denominator at Campagnolo®: the standards that the **Campy Tech Lab™** imposes on the products it develops exceed even up to five times those prescribed by the regulations, because our most indispensable aim is to protect the rider.

And then the victories of so many champions of the past and present, who with our products have realised and continue to realise their most fantastic dreams, represent the essence of excellence and the quest for the maximum performance that the **Campy Tech Lab™** makes available to all cycling lovers who day by day take our technologies out onto the roads of the world... and you know very well that no one ever wins by chance.

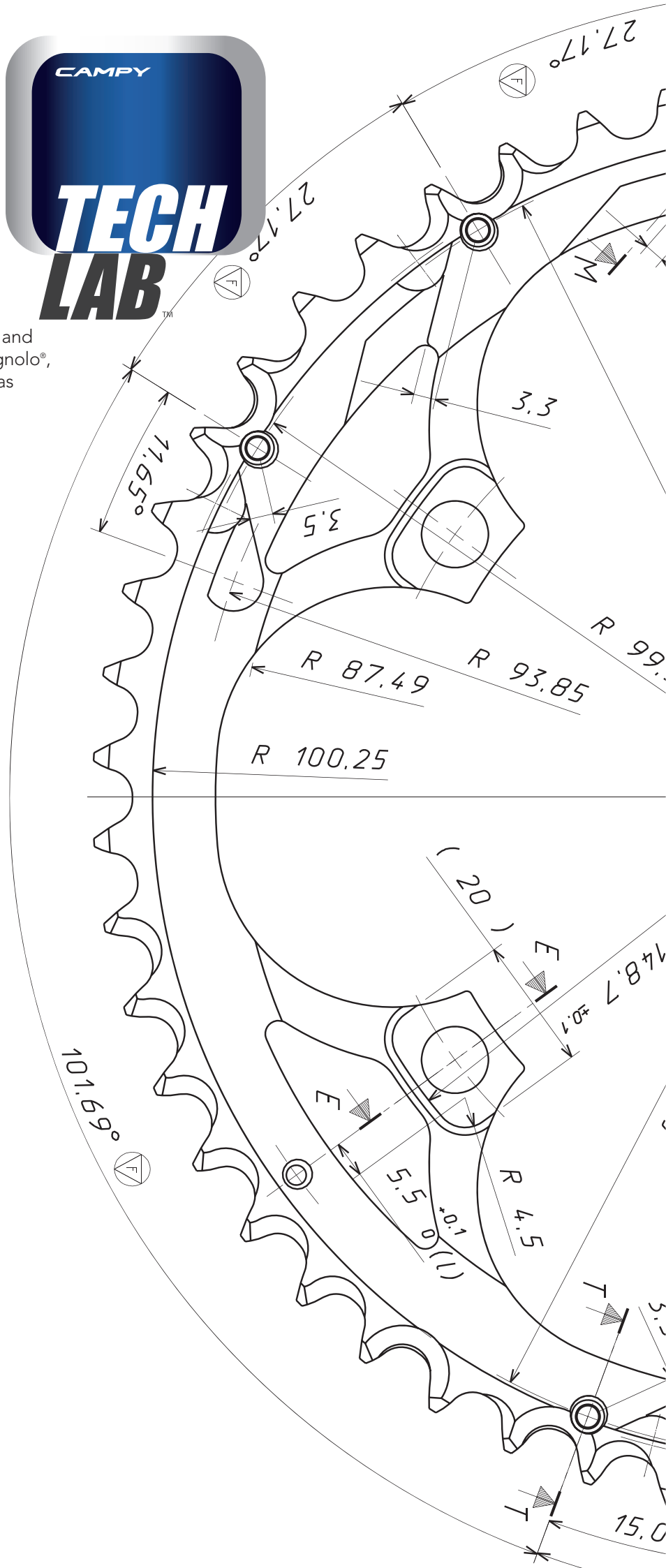



## QR CODE®: Campagnolo®'s technologies on your smartphone

Campagnolo® offers you a great opportunity. In this catalogue will find a series of two-dimensional matrix codes called QR codes® (see sample image), which will enable you to access a series of in-depth videos on Campagnolo®'s technologies on your smartphone.

To see the videos on your smartphone, please follow these simple instructions.

Scan the QR code® and follow the instructions given by the reading software.

Your smartphone will connect to Campagnolo®'s mobile website and you will be able to see the videos you wish to access.

The service is free of charge, except for internet connection costs from your operator. Please contact your operator for the best data traffic rates available.

If your smartphone does not have a QR code® reader, an internet search with the words "QR code® reader" will allow you to download a free one online.

**SCAN THE  
TWO-DIMENSIONAL  
MATRIX CODE WITH  
YOUR SMARTPHONE  
AND DISCOVER ALL  
THE INFORMATION  
ON CAMPAGNOLO®'S  
TECHNOLOGIES.**

QR code® is registered trademarks of DENSO WAVE INCORPORATED. Copywrite(C) 2000-2010 DENSO WAVE INCORPORATED. All right reserved.



CULT™

ERGPOWER  
POWER CONTROL™

ULTRA SHIFT SYSTEM™



POWER TORQUE SYSTEM™

EXTREME PERFORMANCE  
SHIFTING SYSTEM™

ULTRA TORQUE™



## 10 AND 11 SPEED CRANKSETS

**Campagnolo® cranksets are the best you could ever want for your bicycle.**

From Super Record™ to Veloce, every detail is designed and engineered with the utmost attention to provide the maximum performance.

The carbon fibre cranks incorporate our Ultra-Hollow Structure (UHS™) technology to provide the maximum lightness and strength; the chainrings have been designed and engineered to give the maximum shifting performance (X.P.S.S.™ e MPS™), and thanks to the use of ball/bearing systems like USB™ and CULT™, you can be sure to not lose even one watt of power.

### **XIPISIS EXTREME PERFORMANCE SHIFTING SYSTEM™**

This is not just the acronym of eXtreme Performance Shifting System™. X.P.S.S.™ incorporates a project with a specific goal: giving Campagnolo®'s 11-speed groupsets the best shifting performance possible. And the Campy Tach Lab™ has hit the mark once again.

The new design of the chains up shifting and downshifting has been analysed to the smallest detail with mathematical functions to simulate possible movements of the chain on the chainrings and design optimal angles. Furthermore, repeated lab tests on the speed and precision of the shifting action have allowed us to complete the product's optimization.

#### **The profile of the chainring teeth**

is constructed to make their action extremely effective and to be in perfect harmony with the 11-speed chain and with **the cleverly shaped** front derailleur to accompany the movement of the chain with extreme speed and precision, even under load.



**The secret of this amazing result is a perfect combination and integration of all the drive train's components.** Each one of them is designed to perfectly fit and work with the rest. This is the only way you will be able to enjoy the extraordinary performance of the X.P.S.S.™ system.

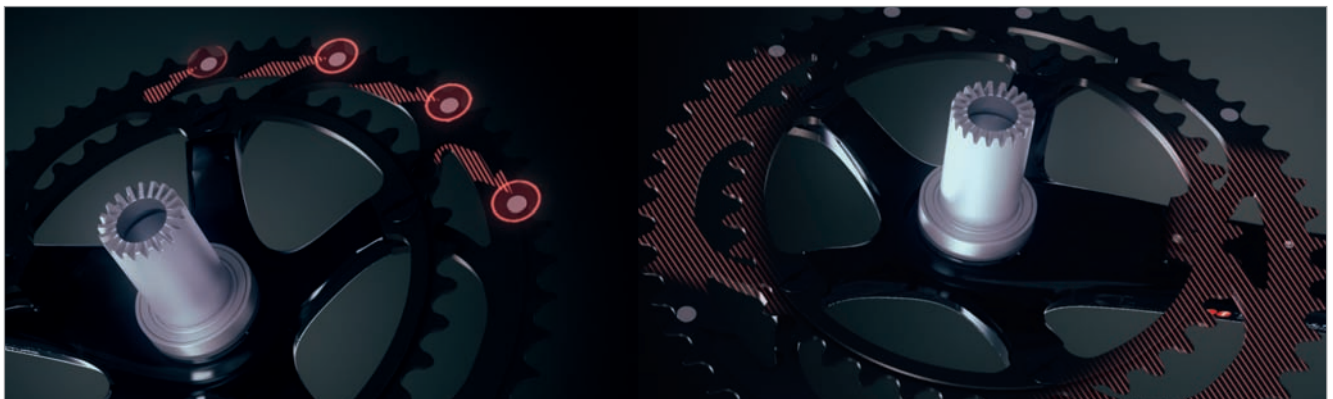
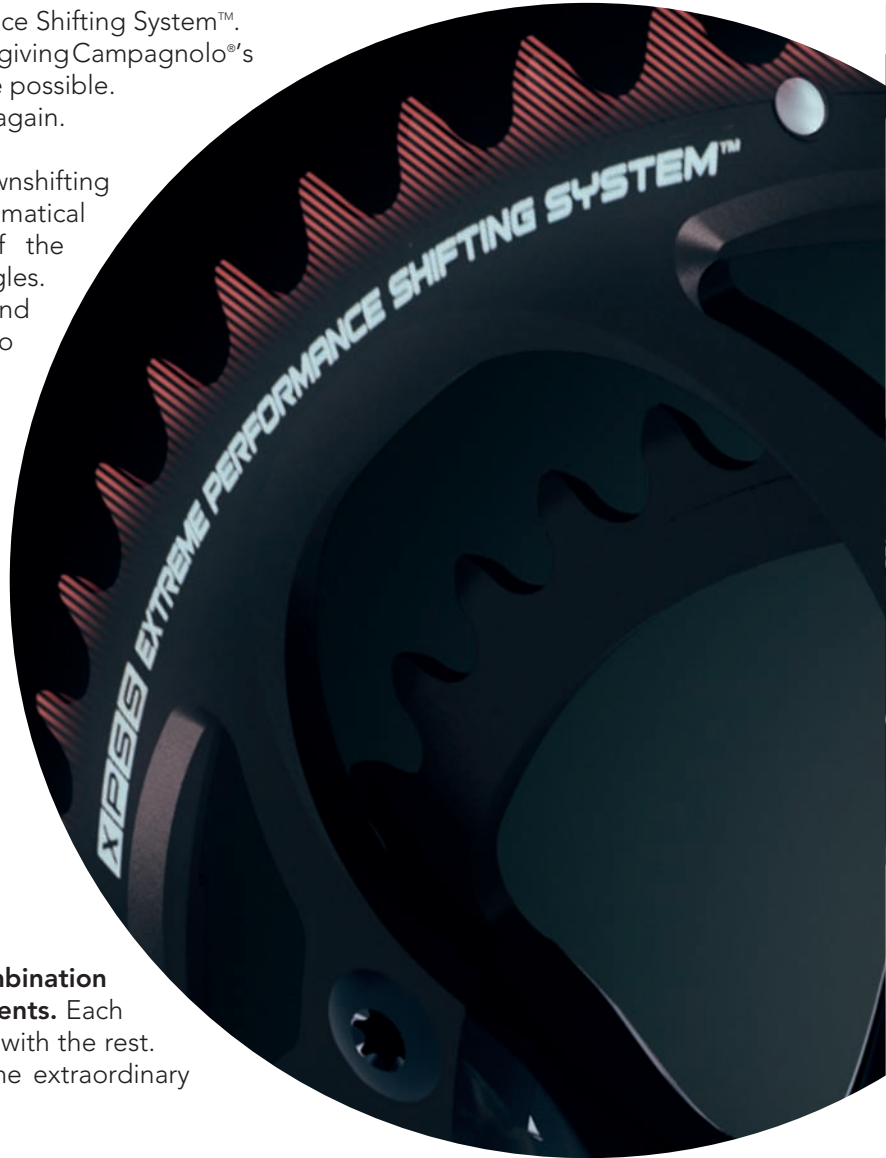



## **MPS** MICRO PRECISION SHIFTING™ SYSTEM

Campagnolo® is constantly focused on the performance of its groupsets for all its ranges, from Super Record™ to Veloce™.

Its Micro Shifting Performance™ fully reflects this philosophy.

Indeed, our Centaur™ and Veloce™ can attain shifting performances never reached before in a 10-speed group set. Absolute precision, speed and a reduction of the distance covered by the chain when moving from one chainring to another are in line with the performances of the “bigger” 11-speed groupsets.

Mechanical work on the outer chainring is proof of the obsessive attention to detail and the persistence of the engineers at our Campy Tech Lab™ expect the maximum performance from all of Campagnolo's products. The result is amazing and now moving from one chainring to another, even under load, will no longer be a problem!

### **MPS™:**

Optimised design of the up-shift and down-shift zones and of the profile of the teeth – enables fast and precise shifting in all types of conditions.



### **8 CHAIN UP SHIFTING AREAS AND 2 CHAIN DOWNSHIFTING AREAS:**

faster and more precise shifting, even under stress.

SCAN THE  
TWO-DIMENSIONAL  
MATRIX CODE WITH  
YOUR SMARTPHONE  
AND DISCOVER ALL THE  
INFORMATION ON THIS  
TECHNOLOGY.



# ULTRA TORQUE™



Lightness, rigidity, and easy maintenance:  
Ultra-Torque™.

Six years after introducing the Ultra-Torque™ system, it is still considered, the best performing crank-set spindle in terms of stiffness, low weight and efficiency of power transmission.

Campagnolo® found a way to permanently conjoin the semi-axles of the bottom bracket to the respective crankset arms.

This redesign made it possible to considerably **reduce the lateral dimensions at the axle level** and prevent annoying contact with the ankles when turning the pedals.







Assembly is simplistic: **one single oversize bolt is enough to integrate the two semi-axes**  
With regard to torque transmission efficiency, this system is equally as effective as a single piece axle.

Furthermore, despite the narrow side profile, we have been able to position the bearings outside the bottom bracket shell, resulting in greater axle rigidity from the increased axle diameter. This breakthrough was obtained by using an ingenious mechanical system derived from many years' motoring experience in the rotation axle and engine shaft coupling sector: the **Hirth joint**. In short, this is a joint with self-centring and self-aligning frontal teeth located in the middle of the bottom-bracket axle where the ends of the semi-axes, integrated with the crankset arms, come into contact.



SCAN THE  
TWO-DIMENSIONAL  
MATRIX CODE WITH  
YOUR SMARTPHONE  
AND DISCOVER ALL THE  
INFORMATION ON THIS  
TECHNOLOGY..



## POWER TORQUE SYSTEM™

Since 2011, the Athena 11s, Centaur, and Veloce groupsets feature the Power Torque™ system. The new solution was immediately applauded and embraced with enthusiasm thanks to the incredibly high level of performance found in these mid-range groupsets, as well as the ease of use and the high reliability.

**The axle is a single piece** firmly fixed to the right crank of the crankset. The perfect coupling between bottom bracket and left crank is assured by the **special geometry of the two components**, a solution that guarantees the maximum reliability.

To make the bottom bracket more efficient, we also worked on the inner part. Thanks to an elaborate sequence of thicknesses, we were able to obtain an incredibly **light axle** while offering an absolute response in terms of rigidity. Thanks to the studies conducted by the Campy Tech Lab™ engineers, material was removed in the zones that could be lightened but at the same time the points of maximum stress were strengthened. Only in this way was it possible to achieve such a high technical value.

A careful study of the dimensions made it possible to maintain the lateral measurements already appreciated with the Ultra Torque™ system, thus guaranteeing the **maximum freedom of movement** and reducing the possibility of contact with the rider's shoes.

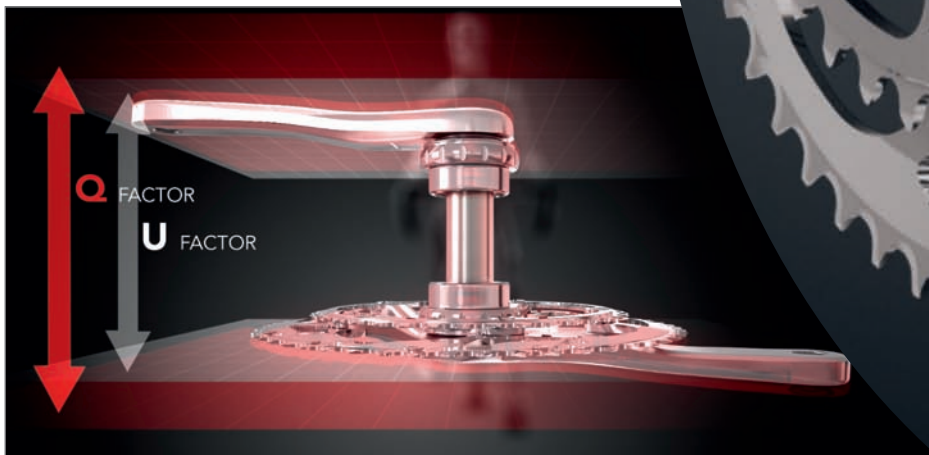



The Campagnolo® engineers concentrated on ensuring that installation and servicing would be extremely simple. The most complicated work has been done, so now it's up to you to carry out four simple steps to fit the Power Torque System™ crankset quickly and with no potential for error.

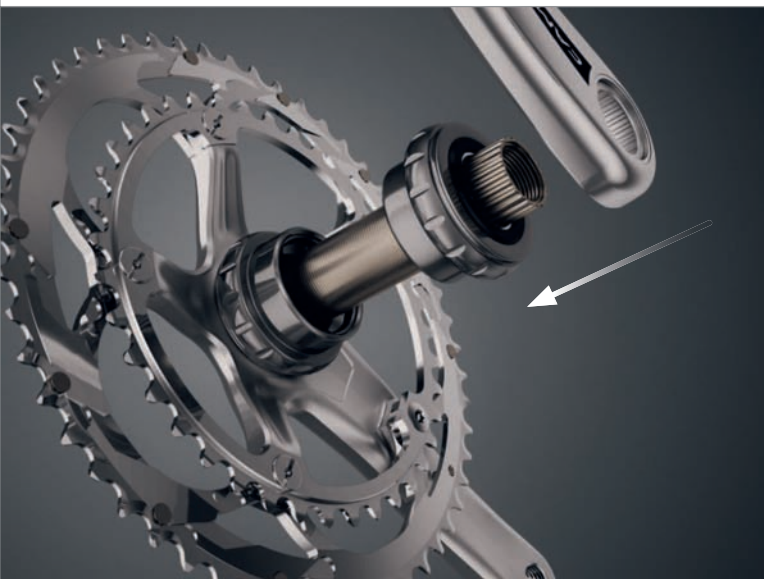
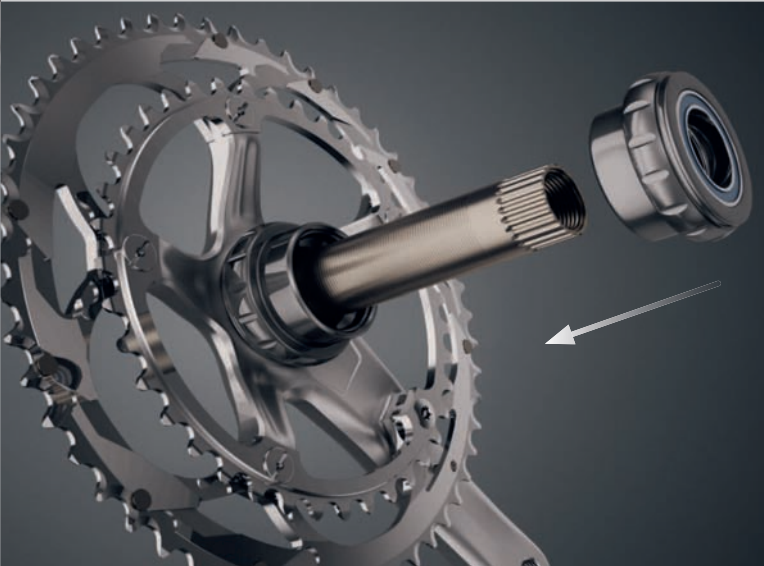

The right-hand bearing is already locked in the axle in correspondence with the crankset; the other is pre-inserted in the left-hand cup. No special tool is required, and the new crankset is ready to propel you over endless miles. That's right, because another one of the objectives of the Power Torque System™ project was prolonged operating resistance.

**The tests conducted by the Campy Tech Lab™ were very exacting in this regard. Now it's your turn.**

SCAN THE  
TWO-DIMENSIONAL  
MATRIX CODE WITH  
YOUR SMARTPHONE  
AND DISCOVER ALL THE  
INFORMATION ON THIS  
TECHNOLOGY.





**To understand what CULT™ is all about and what advantages it offers in terms of the performance of the wheels and cranksets that apply this technology, there's only one thing to do: try it!**

We could describe it, praise its performance features, and give you the technical specifications, but it's impossible to transmit the real sensations and the differences you can perceive right from the first pedal rotation with wheels and cranksets bearing the CULT™ name.

...But in any case, Campagnolo® wants to illustrate the exceptional results shown by the products using CULT™ technology during the tests carried out by the Campy Tech Lab™ engineers.

CULT™ is the combination of the highest quality ceramic ball bearings available on the market and races made of **Cronitect®**, chromium stainless steel, i.e. the technological wonder made by the German company Schaeffler. Ceramic ball bearings make it possible to reduce friction to the minimum and maintain consistent performance over time; bearing races made of Cronitect® with thermochemical surface treatment make the sliding surface of the bearings extremely hard and resistant to wear.

But that's not all. Friction of the wheel and crankset is extremely reduced thanks to the minimal lubrication system required by CULT™: only a thin film of oil in the place of the grease traditionally used.

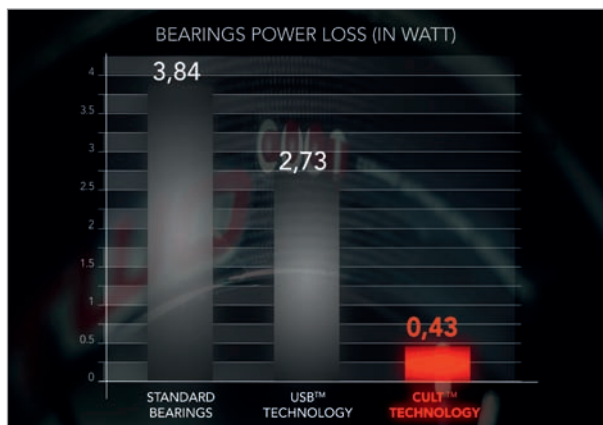

The results from the Campy Tech Lab™? Surprising and beyond all expectations:

- 9 times smoother than the standard solutions.
- Resistance to corrosion: zero wear and tear on bearings and balls.
- Friction coefficient: the lowest in the world of cranksets thanks to lubrication with oil instead of grease.
- 3,5 Watt more power at each pedal stroke, increasing along with the increase in speed.

Even more surprising are the results achieved on the road. The smoothness of your pedal stroke increases with the increase in speed and the sensation is consistently fluid and efficient pedalling.

CULT™ will enable you to boost your performance, but that's not all. Thanks to the new materials with extremely high hardness coefficients, the performance of your crankset will be totally unaltered over time.

**The technology and the materials of the CULT™ system make it possible to lubricate with just a thin layer of oil rather than grease normally used for the parts subject to friction. This enables a friction coefficient that is nine times less than the standard and more than 3,5 watts extra power for each pedal stroke.**







**Our ceramic USB™ - Ultra Smooth Bearings guarantee extremely high smoothness.**  
Perfectly smooth surfaces and lower friction to reduce loss of power are the most interesting features.

Add on the reduced weight and resistance to corrosion and you will understand why we can give you the best thanks to USB™. All your power will be transferred onto the road.

USB™ - Ultra Smooth Bearings technology is used for the Record™ cranksets, the Shamal™ Ultra™ wheels and all the wheels in the Bullet Ultra™ and Bullet™ range.



SCAN THE  
TWO-DIMENSIONAL  
MATRIX CODE WITH  
YOUR SMARTPHONE  
AND DISCOVER ALL THE  
INFORMATION ON THIS  
TECHNOLOGY.



## CAMPAGNOLO® CONTROLS

Not only Ergopower™. Campagnolo® can now count on another ally in the race against time thanks to the brand new 10- and 11-speed controls for Triathlon and Time Trial racing.

The big novelty for 2012 that complete our controls' range together with the Ergopower™ controls, the maximum in terms of ergonomics and performance.

## CONTROLS CAMPAGNOLO® ERGOPOWER™

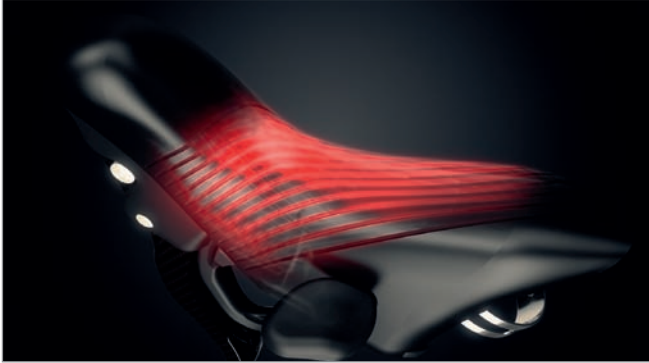

**MULTI-DENSITY VARI-CUSHION™ HOOD:**

greater softness in the palm support area - greater rigidity in the gripping area.





## ERGONOMICS

The shape of the body conforms to your hands perfectly.

The body of the control reproduces exactly the asymmetry of the human hand. This increases the contact with the palm and allows for various riding positions, ensuring maximum safety in all riding positions.



## COMFORT

The shape allows you to easily reach the levers, regardless of your riding position and the size of your hands.

The studies conducted on the position of cyclists' hands, showed three different steering positions depending on the course and the steering style. Based on these studies, Campagnolo® created the particular and exclusive form of the Ergopower™ controls that enable you to steer with safety and comfort. In addition, **the special insert for large hands increases the distance of the levers by 8%, creating sufficient space for braking and shifting, always with the maximum safety.** The Vari-Cushion™ system is the shock absorber that envelops the body of the controls. **The particular geometry of the hoods made of material of variable density,** stretchy and hypoallergenic, absorbs vibrations, enabling you to stay in the saddle for many hours without hand fatigue.



## EFFECTIVE BRAKING

The lever's Ultra-Shift™ shape lets you squeeze the brakes with greater power. In particular, **it allows you to brake powerfully and promptly.** when the hands are gripping high up. This is a plus that will allow professionals to chat with greater peace of mind before getting on with the serious business.

SCAN THE  
TWO-DIMENSIONAL  
MATRIX CODE WITH  
YOUR SMARTPHONE  
AND DISCOVER ALL THE  
INFORMATION ON THIS  
TECHNOLOGY.



## ERGOPOWER™ ULTRA-SHIFT™ CONTROLS

Quickly take the lead and leave your rivals motionless.

The Ultra-Shift™ control by Campagnolo® is regarded by everyone as the fastest and most precise. Thanks to the Ultra-Shift™ patented system; **you can move the chain simultaneously up 3 sprockets and then 5 down.** Furthermore, the lever design allows for an ever lighter shifting, whilst maintaining the “click” sound featured on all Campagnolo® controls. The Ultra-Shift™ system is featured on Super Record™, Record™ and Chorus™ 11 Speed groupset ranges.



SCAN THE  
TWO-DIMENSIONAL  
MATRIX CODE WITH  
YOUR SMARTPHONE  
AND DISCOVER ALL THE  
INFORMATION ON THIS  
TECHNOLOGY.



## ERGOPOWER™ POWER-SHIFT™ CONTROLS

**A system that is both user-friendly and high-performing, with no compromises.**

Once again, the design for Campagnolo®'s controls has reached extraordinary levels: the “one lever – one control” system, greatly appreciated by riders all over the world, remains. The system has the same ergonomics successfully tested on our Ergopower™ controls and comfort is ensured by the Vary-Cushion™ hoods along with the numerous ergonomic solutions of the well-tested Ultra-Shift™.

With the Power-Shift™ system designed by Campy Tech Lab™ and featured on our 2011 Athena™ 11 Speed, Centaur™ and Veloce™ 10 Speed groupset ranges, **you can move up 3 sprockets at a time and move down by one.** Controls have been designed to maximize shifting performances: precision and speed will enhance the qualities of your Campagnolo® drivetrain and will allow you to face all kinds of routes with zero concerns.

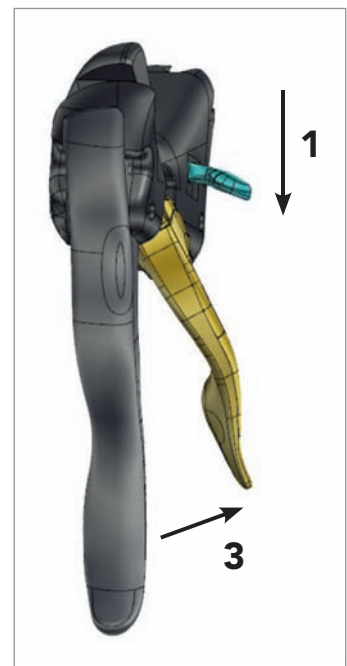

**POWER SHIFT SYSTEM™ MECHANISM:**  
User-friendly - 3-sprocket up shifting, and  
1-sprocket downshifting in a single stroke.



## CAMPAGNOLO® TT BAR-END CONTROLS

The concentration of technology in a space reduced by 33% compared to the traditional Campagnolo® Ergopower™ controls.

The new bar-end shifters have been developed in collaboration with time-trial racing pros. In terms of ergonomics, the result is highly significant: for the triathlete or time trialist, at the moment in which he needs to shift, these controls reduce the movements of the fingers and the hand to the minimum, without losing the position of maximum aerodynamics and without diverting energies from the fluid motion of the pedal stroke.



The exclusive Return-to-Zero system makes it possible to keep the lever always in the optimal start position (you can choose the best start position depending on the type of handlebar and on the best ergonomics). Thanks to this system, the rider maintains the position of maximum aerodynamic penetration and the best position of the fingers on the controls.

But that's not all: one of the most highly appreciated features of Campagnolo® controls has always been the Multi-Shifting System™ system. So also for the Triathlon and Time Trial disciplines, Campagnolo wanted to maintain this extremely important technology, which makes it possible to upshift and downshift one, two, or even three cogs, by the rider's choice. The front derailleur control also features the Micro-Adjustment System™, which makes it possible to keep the front derailleur cage always in the optimal position.



### RETURN-TO-ZERO

the control lever always returns to the point of optimal ergonomics and maximum aerodynamic penetration.

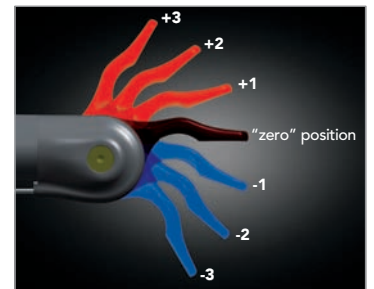

### MULTI-SHIFTING

makes it possible to choose upshifting or downshifting by 1, 2, or 3 cogs with a single shift.

## ULTRA-SHIFT™ REAR DERAILLEUR

On the Campagnolo® rear derailleur you immediately notice the **oversized dimensions of the outer plate** that wraps the lower and upper bodies.



### ULTRA-SHIFT™ GEOMETRY:

the exclusive design of the parallelogram makes shifting extremely fast and precise even under stress.

This particular feature, along with the parallelogram, creates the Ultra-Shift™ geometry, the technology that assures the excellent performance of the latest generation of 11-speed and 10-speed drivetrains.

The special form, designed and developed entirely in the Campy Tech Lab™, gives the derailleur an extremely high degree of torsional stiffness. But what's more, the form makes shifting **fast, reactive, and precise in any situation**, even under stress. But for the Super Record™ 11-speed rear derailleur, Campagnolo® wanted to enhance the performance features to make it even more unique, using unidirectional carbon fibre for the upper and lower bodies.



The result: **the first rear derailleur made entirely of carbon fibre**, with a Formula 1 aesthetic and a markedly reduced weight compared to the versions in aluminium. And above all, the overall rigidity of the system is considerably increased, which in terms of performance translates into the **best shifting possible to be found on racing bikes**.

**ENVELOPING OVERSIZED PLATE** makes the rear derailleur extremely rigid – reduces the possibility of play, increasing the life and reliability of the rear derailleur.

SCAN THE  
TWO-DIMENSIONAL  
MATRIX CODE WITH  
YOUR SMARTPHONE  
AND DISCOVER ALL THE  
INFORMATION ON THIS  
TECHNOLOGY.





## ULTRA-SHIFT™ FRONT DERAILLEUR

11 speeds characterised by the Ultra-Shift™ front derailleur that, thanks to the “funnel” design of the derailleur cage, makes **shifting extremely fast and precise** and enables easy adjustment.

Furthermore, the anti-friction treatment extends their lifetime.

As simple as it is effective and reliable.

The front derailleurs of the 10-speed groupsets have always represented a guarantee of excellent performance.

For this reason, also for the 2012 range Campagnolo® has maintained the same configuration characterised by the **Z-Shape™** design of the inner cage and the M-Brace™ front derailleur body. This combination, thanks to the new design of the MPS™ chainrings, **elevates shifting to incredibly high levels of precision, speed, and reliability.**



**SPECIAL INNER CAGE DESIGN:**  
greater rigidity – faster shifting – more space for the chain crossovers.

## ULTRA-SHIFT™ 11 SPEED SPROCKET SET

Eleven sprockets that are even more efficient despite the reduction of the thicknesses?

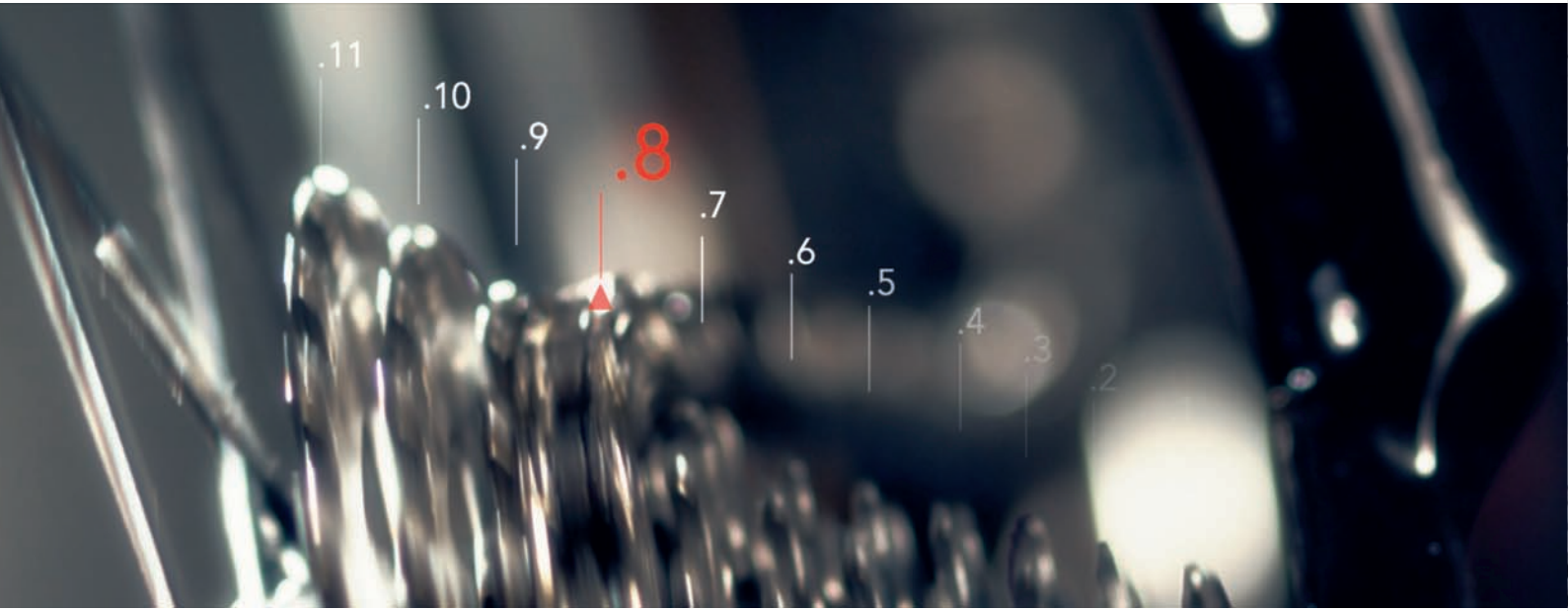

We have succeeded. The teeth have been designed to optimize the speed and fluidity of shifting. This form reduces stress on the chain which ascends more easily onto the higher diameter sprockets.



**REINFORCED MOUNTS FOR SECOND AND THIRD TRIPLETS:**  
Greater sprocket set rigidity – performance, precision.

The large sprockets are divided into sets of three and are mounted on a new aluminium frame.

Thanks to this, rigidity increases 180% and the individual sprockets are 70% more resistant to torsion.

### ULTRA-SHIFT™ SYNCHRONIZATION

Sprocket tuning allows for maximum shifting performance without hesitation: fast, accurate, and quiet, even under stress.

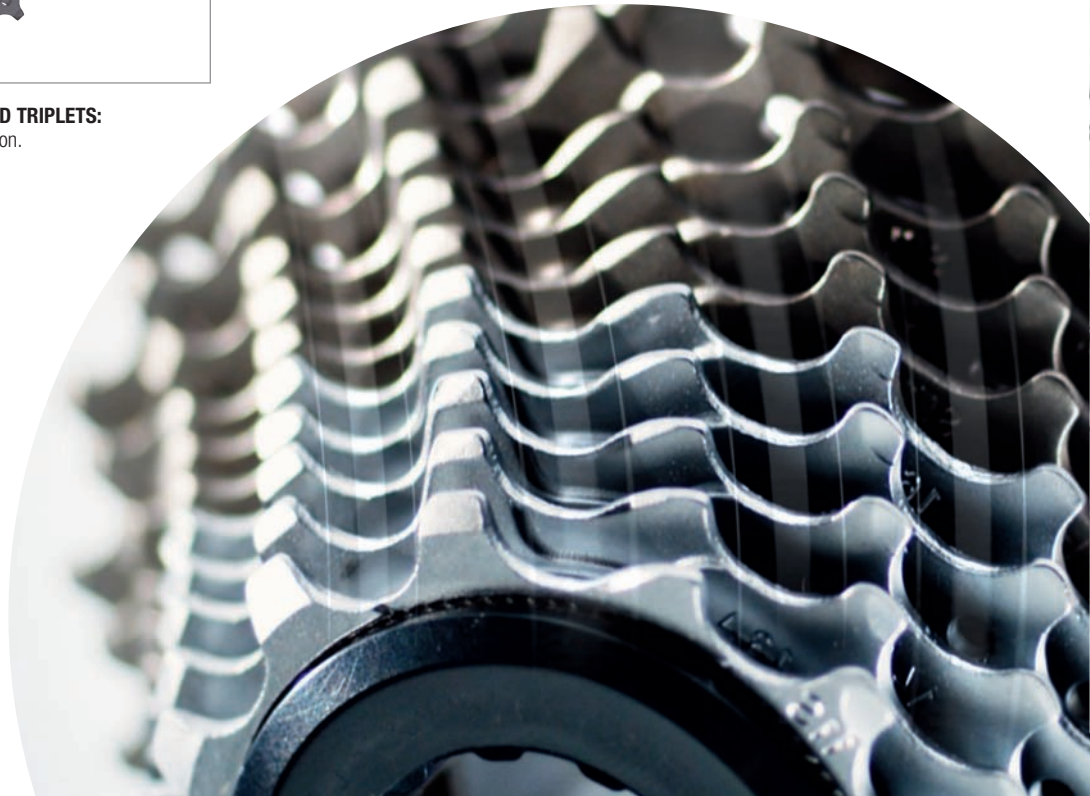



## ULTRA-DRIVE™ 10 SPEED SPROCKET SET

The Centaur™ 10-Speed and Veloce™ 10-Speed groupsets maintain the Ultra-Drive™ system dedicated to and optimised for 10-speed drivetrains.

The maximum synchronisation between the sprockets and precise machining of the teeth achieve first-class shifting performance.

The Nickel-Chrome surface treatment makes the sprockets extremely resistant and durable and prolongs the life of the chain.



**ULTRA-DRIVE™  
TEETH DESIGN:**  
optimized upshifting.



## ULTRA-LINK™ 11 SPEED CHAIN



The chain is the component that transmits the power of the pedals to the wheel. As such, it must be extremely reliable, efficient in transmitting power, able to reduce friction to the minimum, and prove a quick and precise response to the front and rear derailleur controls. These are characteristics that can be achieved thanks to the combined engineering of chain, gears, and sprockets.

For the links, we used a type of steel with a special Ni-PTFE treatment that, in addition to increasing the resistance by more than 20% with respect to standard steels, reduces friction to the minimum and increases the smoothness of the chain.

The exclusive Ultra-Link™ closing system represents the “key to safety” of the chain for 11-speed drivetrains: the locking pin has been created so that once it is closed using the special UT-CN300 tool, it is absolutely resistant and safe.



### 11-SPEED CHAIN:

Special steel, 20% stronger – special outer link design for faster shifting even under stress.

## HD-LINK™ 10 SPEED CHAIN



For 10-speed groupsets you can choose between two models of chain, both featuring the HD-Link closure system and surface treatment to reduce friction: the CC or the C10, which differ only in the lightening of the outer plates that gives the CC a 2% savings in weight.

The links and pins of the 10-speed chains are designed and optimised to be coupled with the teeth of the Campagnolo® 10-speed gears and sprockets.

This is why Campagnolo® always strongly advises using original components that maintain their excellent shifting performance and prolong the life of the components subject to friction.



### 10-SPEED CHAIN WITH HD-LINK™ CHAIN LINK FASTENING SYSTEM:

High strength link locking – greater safety and longer chain life.



## ULTRA-TORQUE™ INTEGRATED CUPS AND POWER TORQUE SYSTEM™

### Uniquely compatible with all the frames on the market.

Thanks to an accurate design focused on our clients' needs, Campagnolo®'s crank sets can be mounted on any kind of frame: from Italian frames to English ones, on 86.5x41 press fits or on oversized bottom brackets with BB30, BBRight, BB90 frames.

This enables us to maintain celebrated benefits such as rigidity, lightness and performance in keeping with the typical timing results measured by Campagnolo®'s crank sets.

What's more, this solution enables you to switch to a different frame in future without having to change the crank set. This is why Campagnolo® has chosen to maintain the well-tested and efficient geometries designed for the Ultra-Torque™ crank set while offering cups compatible on all frames available, firmly believing in oversized bottom bracket shells.

Campagnolo®'s integrated cups, available for both Ultra-Torque™ crank sets and the Power-Torque System™, have the same function standard cups have, along with the extremely important technical advantage of maintaining bearing seating as wide as possible from each other.

This translates into a **considerable reduction of forces acting** on the bearings; the advantage is **smoothnes** and a **stable delle performance over time**.



### ULTRA-TORQUE™ CUPS

GROUPSET	Standard ITA	Standard ENG	BB30 68X42	86,5X41	BB30 68X46	BB Right

### POWER TORQUE SYSTEM™ CUPS

GROUPSET	Standard ITA	Standard ENG	BB30 68X42	86,5X41	BB30 68X46

### POWER TORQUE SYSTEM™ CUPS FOR CYCLOCROSS

CRANKSETS	Standard ITA	Standard ENG

## CAMPAGNOLO® BRAKES

Campagnolo® brakes feature an exclusive technology:  
**the Dual Pivot system.**

### What do we mean by Dual Pivot?

It's the exclusive Campagnolo® system that exploits dual pivot points for actuating the brake arms. In other words, in correspondence to force applied by the cyclist on the brake lever, a greater force is applied on the brake caused precisely by the dual pivots.



### What are the advantages of the Dual Pivot system?

The dual pivoting of the brake arms makes it possible to increase the actuation force of the brake and to modulate braking based on the needs of the moment, making braking consistently safe and controlled.

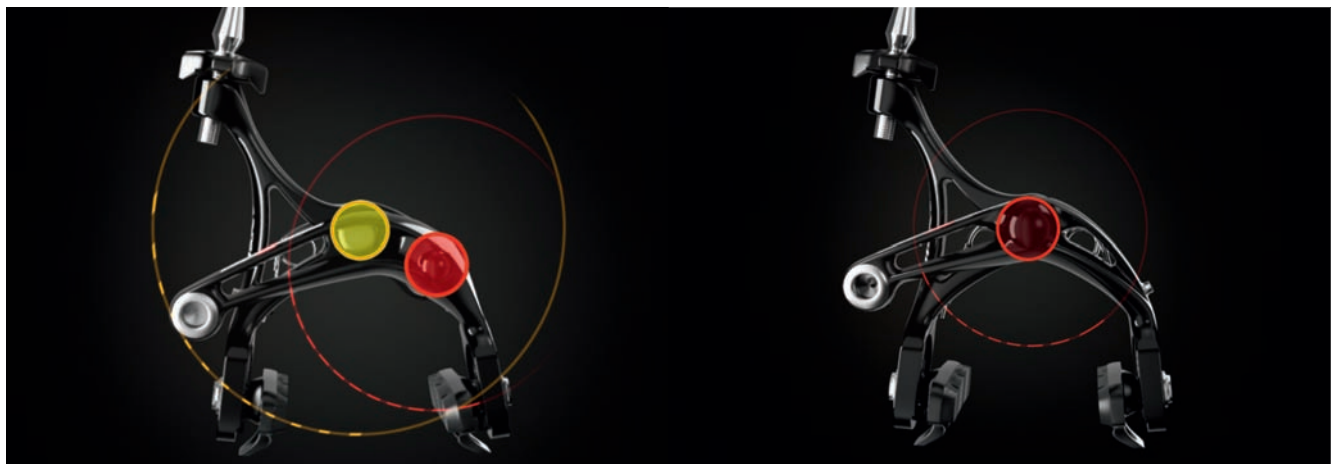

DUAL-PIVOT FRONT BRAKE  
DUAL-PIVOT REAR BRAKE

MONO-PIVOT REAR BRAKE



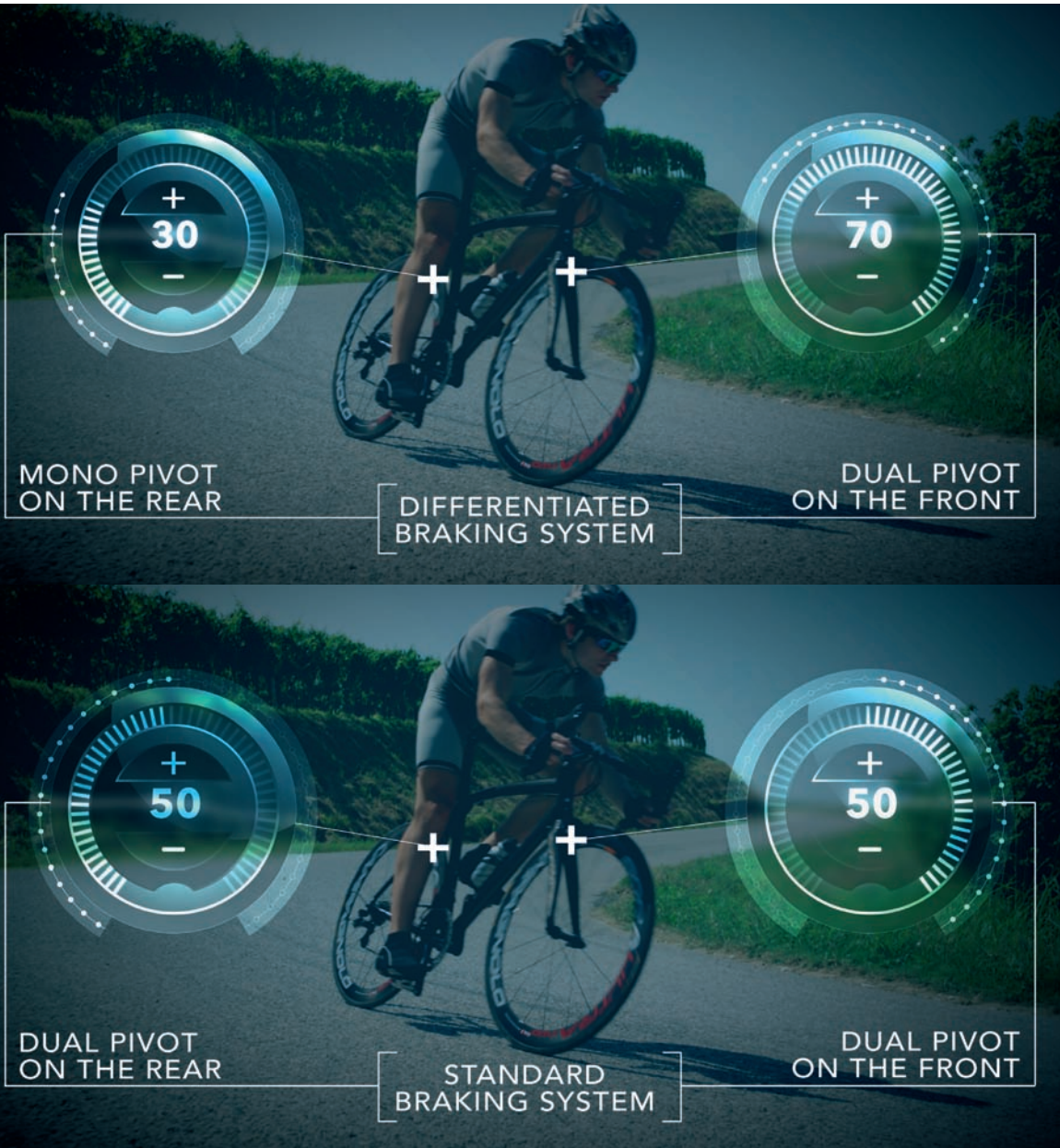

**But do cyclists always need braking that is decisive and powerful?**

As is well-known, the braking of a road bike is divided into about 70% on the front and 30% on the rear.

The answer, therefore, is certainly positive in the case of the front brake, while for the rear brake, the answer becomes a personal choice and is provided based on the style of riding, weather conditions, and also the material of the braking tracks of the wheels.

This is why, for the Super Record™, Record™, Chorus™ and Athena™ brakes, Campagnolo® offers the two options for the rear brake: mono pivot for those who prefer a lighter brake with a less powerful braking action, and dual pivot for riders who want to have greater braking power on the rear as well.



**NEW BRAKE PADS MADE ESPECIALLY FOR CARBON WHEELS:**  
the new blend increases the brake performance on both dry and wet surfaces without increasing the wear and tear on the pad. For a more modular and more secure stop.



**LIGHTENED SHOE HOLDERS WITH FACILITATED BRAKE SHOE COUPLING/UNCOUPLING SYSTEM:**  
reduced weight – facilitates easy brake shoe replacement – greater safety.



Giulia.  
During a race expects  
the best from herself.  
And from her groupset, too.



## 10 SPEED GROUPSETS

28 | VELOCE™

36 | CENTAUR™

## 11 SPEED GROUPSETS

44 | ATHENA™

52 | CHORUS™

60 | RECORD™

68 | SUPER RECORD™

## CAMPAGNOLO® INTEGRATED DRIVETRAINS

**ONLY COMPONENTS DESIGNED TO OPERATE TOGETHER CAN GUARANTEE THE MAXIMUM PERFORMANCE**

The drivetrain is a complex precision mechanism, and guaranteeing its maximum performance has always been our objective. But what is required to safeguard it? Metaphorically speaking, a drivetrain is like the human body, where the organs are "designed" to interact with each other and to ensure the ideal operation of the overall "mechanism".

But what happens if we replace an organ?

There are alternative solutions on the market that allow the interaction with the other components that make up a drivetrain but, as in nature, where there are no replicable organs with the exact same DNA, also in the field of mechanical engineering the solutions designed are unique, just like the components of a Campagnolo® drivetrain are unique and integrated.

Only with the Campagnolo® integrated drivetrain system, and thanks to the interaction of all its individual components, can we achieve both ours and your objective: the maximum performance and reliability.

Materials, design, dimensions: Nothing is left to chance. Only in this way can we obtain a group of components with superior performance: a Campagnolo® groupset.



Yoji.

The last person who called him  
a "Sunday cyclist" finished  
5 minutes behind on Mount Fuji.





VELOCE™

POWER TORQUE SYSTEM™

CAMPAGNOLA.

CAMPAGNOLA.



368 g

Deep Black

Bright Silver

Colours available for hoods and casings



Special colours upon request of bicycle manufacturers



## VELOCE™ ERGOPOWER™ POWER SHIFT™ CONTROLS

Designed for your hands.  
An in-depth study of the ergonomics between the hand and the control lever made it possible to achieve a level of safety, comfort, and speed of control far beyond all expectations. On a climb or in a sprint, your hands will always find the ideal position, without compromise.

### CAMPAGNOLO® EXCLUSIVE TECHNOLOGIES:

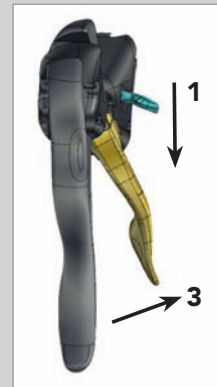

**POWER-SHIFT™ MECHANISM:**  
extremely precise and rapid, it allows you to upshift three sprockets at a time or downshift by one with just a single action.



**ULTRA-SHIFT™ ERGONOMICS:**  
ensures a firm grip on the handlebars with fast and precise control of the levers. The special ergonomic design makes it possible to assume three different hand positions on the levers compared to the two traditional ones.

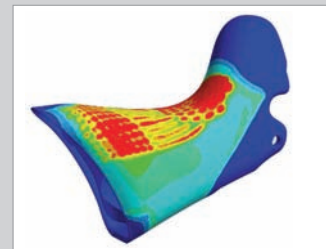

**VARI-CUSHION™ HOOD:**  
made of non-allergenic elastic material, with variable cushioning that provides the maximum comfort and safety even after many hours on the bike. Thanks to a special treatment, it is resistant to UV rays and maintains its original colours without fading.



**DOUBLE CURVATURE BRAKE LEVER:**  
allows you to engage and modulate the brake safely from any hand position.



CAMPAGNOLO® EXCLUSIVE TECHNOLOGIES:

**MPS** MICRO PRECISION SHIFTING™ SYSTEM



The perfect combination between chainring teeth, chain, and front derailleur. A perfectly synchronous system that enables fast and precise shifting even under load.

**POWER TORQUE SYSTEM™**



**POWER TORQUE SYSTEM™ BOTTOM BRACKET:** pressure on the pedals is transmitted efficiently without any power loss.

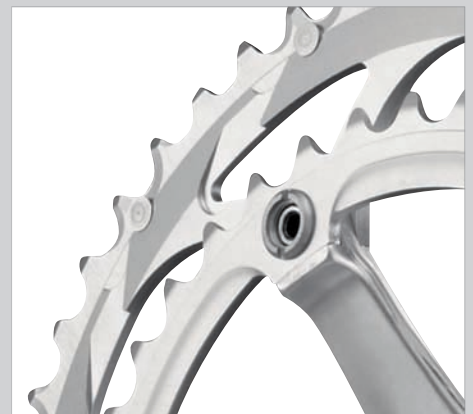

**8 UP SHIFT AND 2 DOWNSHIFT ZONES:** faster and more accurate shifting, even under stress.



Deep Black

753 g

Bright Silver



**VELOCE™ CRANKSET**

The Veloce™ crankset adopts the Power Torque System™ also used for its "big brother" Centaur™. The Power Torque System™ represents the ideal solution for the Campagnolo® 10s drivetrains: high rigidity of cranks and chainrings along with extremely limited weight, efficient power transmission thanks to optimised "Q" and "U" factors, new chainrings with MPS Micro Precision Shifting™ machining of the teeth and new machining on the upward zone of the chain. All this makes the Veloce™ crankset one of the most highly evolved technological solutions, but also one of the most economical, existing on the market.



**Deep Black**

**227 g**



**Bright Silver**

## VELOCE™ REAR DERAILLEUR

Zero compromise. The Veloce™ rear derailleur raises the bar on 10-speed drivetrains, taking them to even higher levels of performance.

The design of the parallelogram and oversized outer plate, already used for the 11-speed drivetrain, is "enveloping" and makes shifting incredibly fast, precise, and silent.

## CAMPAGNOLO® EXCLUSIVE TECHNOLOGIES:



**ULTRA-SHIFT™ ALUMINUM LOWER AND UPPER BODY:**  
lower weight – friction reduction – longer component life.



**ALUMINUM PARALLELOGRAM WITH EXCLUSIVE ULTRA-SHIFT™ GEOMETRY:**  
maximum shifting rigidity, fast actuation, precision, friction reduction.

## FEATURES & BENEFITS

- **Special rubber pulleys:** : reduced friction – less noise



CAMPAGNOLO® EXCLUSIVE TECHNOLOGIES:



258 g

**VELOCE™ SPROCKET SET**

Chain and sprockets have to work in perfect harmony: this is the reason why we have optimised the profile of the sprocket teeth. The result is perfect synchronisation in traction and rapid shifting thanks to the Ultra-Drive™ design.

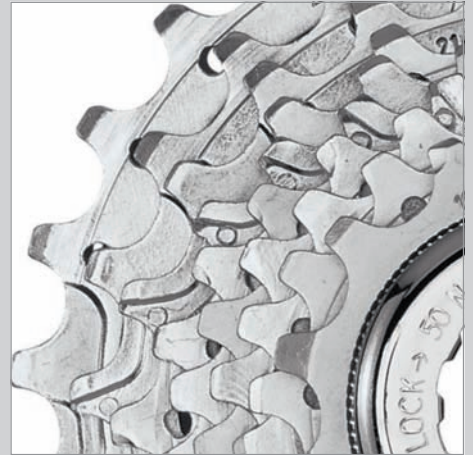

**ULTRA-DRIVE™ TEETH DESIGN:**  
enables consistently responsive, fast, and precise shifting.



**SPROCKET SYNCHRONIZATION:**  
sprocket tuning is carefully designed to make shifting faster and more accurate – less chain stress.

**FEATURES & BENEFITS**



- **Outer galvanized treatment:** reduces chain/sprocket friction – extends sprockets' life

**Bright Silver**



**98 g**

**Deep Black**



## VELOCE™ FRONT DERAILLEUR

Less than 100 grams!

...Plus no compromise in terms of rigidity, precision, and shifting speed. The design of the Veloce™ front derailleur cage enables perfect handling of both traditional and compact cranksets.

## FEATURES & BENEFITS

- **Nickel chrome cage:** longer component life – absolute rust protection
- **Compatible for Standard and Compact cranksets:** the groupset can be used with any 10-speed crank set

## CAMPAGNOLO® EXCLUSIVE TECHNOLOGIES:



**2,39 g/link**



### HD-LINK™ CHAIN LINK FASTENING SYSTEM:

high strength link locking – greater safety and longer chain life.

## VELOCE™ CHAIN

Preventing energy dispersion is possible.

With the Veloce™ chain, power transmission is assured.

The HD-Link™ system protects you from any risk of the chain not keeping traction at the delicate closure point. Silence and fluidity of pedalling are achieved by the perfect machining of the link profile.

## FEATURES & BENEFITS

- **5.9mm special steel links:** prolongs chain life, reduces wear on chainrings and sprockets
- **Ni-PTFE antifriction treatment:** reduced friction, smooth pedaling, quiet operation and greater efficiency – longer chain life



Deep Black



325 g



Bright Silver

## VELOCE™ BRAKES

You don't have to be a bicycle expert: with the brakes of the Veloce™ groupset you'll have the necessary security at all times. The possibility of orbital brake-pad adjustment makes it possible to obtain the optimal braking torque with any wheel. The forged caliper with double fulcrum design ensures excellent power transmission.

## CAMPAGNOLO® EXCLUSIVE TECHNOLOGIES:



### SPECIAL COMPOUND:

reduction of braking distance on both dry and wet surfaces – longer life for brake pad and rim.

## FEATURES & BENEFITS



- **Adjustable shoe holders:** shoe holders on rim's profile can be micro adjusted – longer life for rims and brake pads



- **Special design for forged aluminum brake arms:** greater bend resistance – lighter
- **Dual Pivot front/rear version:** enhanced rear braking



Ingrid.  
Doesn't need to prove  
anything to anyone. But a  
5 minute lead on her  
boyfriend on Alpe d'Huez  
was one great satisfaction.





Ducati™



Deep Black

375 g



Black & Red



Carbon Finishing

373 g



## CENTAUR™ ERGOPOWER™ CONTROLS

The ergonomic design of the Campagnolo® Ergopower™ controls also used for our 11s groupsets provides the most correct and secure support for the hands in all driving positions. The Centaur™ Ergopower™ controls feature the Power Shift System™ mechanism, which makes it possible to move the chain by three sprockets in downshifting and one in upshifting. Two lever versions are available: in aluminium or in carbon fibre with core in light alloy.

## CAMPAGNOLO® EXCLUSIVE TECHNOLOGIES:

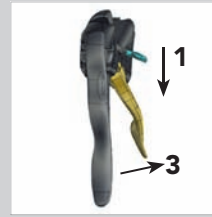

**POWER-SHIFT™ MECHANISM:** extremely fast and precise, it allows you to upshift by three sprockets at a time or downshift by one with just a single action.



**ULTRA-SHIFT™ ERGONOMICS:** ensures a firm grip on the handlebars and fast, precise control of the levers. The special ergonomic design makes it possible to assume three different hand positions on the levers compared to the two traditional ones.

**DOUBLE CURVATURE BRAKE LEVER:** allows you to engage and modulate the brake safely from any hand position.

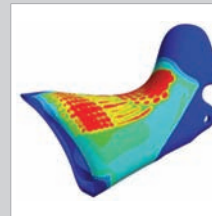

**VARI-CUSHION™ HOOD:** made of non-allergenic elastic material, with variable cushioning that provides the maximum comfort and safety even after many hours on the bike. Thanks to a special treatment, it is resistant to UV rays and maintains its original colours without fading.

## FEATURES & BENEFITS

- Carbon-fiber version with aluminum core available: greater shock resistance – racing style

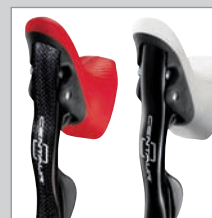

Colours available for hoods and casings

Special colours upon request of bicycle manufacturers

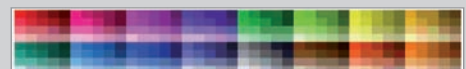





Deep Black

738 g



Black & Red



Carbon  
640 g



## CENTAUR™ CRANKSET

Like a precision timepiece. The Centaur™ crankset is designed to never make a mistake. The rigidity values of the crank and chainrings are at the top of the category. But that's not all... Thanks to the design of the teeth and the eight ascending zones and two descending zones of the chainring, the shifting speed and precision are first-rate, consistently guaranteeing the maximum power transmission.

## CAMPAGNOLO® EXCLUSIVE TECHNOLOGIES:

### MPS MICRO PRECISION SHIFTING™ SYSTEM



**MPS™:** the perfect combination between chainring teeth, chain, and front derailleur. A perfectly synchronous system that enables fast and precise shifting even under load.

### POWER TORQUE SYSTEM™ BOTTOM BRACKET

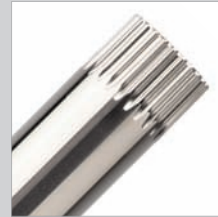

**POWER TORQUE SYSTEM™ BOTTOM BRACKET:** pressure on the pedals is transmitted efficiently without any power loss.



**8 UP SHIFT AND 2 DOWNSHIFT ZONES:** faster and more accurate shifting, even under stress.

## FEATURES & BENEFITS

- Carbon-fiber version available: less weight – racing style



**NEW CENTAUR™ 165mm CARBON CRANKSET (BLACK / BLACK & RED):** it allows for an agile pedal stroke and a correct movement in relation to the length of the lower limbs.



220 g

Black &amp; Red



Deep Black

## CENTAUR™ REAR DERAILLEUR

Absolute precision and reactivity are guaranteed by the new outer plate made of aluminium as per the 11s design. The design of the upper and lower bodies has been optimised to achieve the maximum rigidity and at the same time to reduce the weight. The cage, thanks to the new geometry, is more rigid and lighter, and the silicone rollers reduce vibration and improve the silence of the drivetrain.

## CAMPAGNOLO® EXCLUSIVE TECHNOLOGIES:

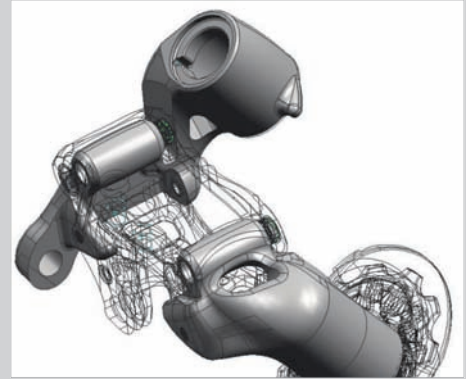

**ULTRA-SHIFT™ ALUMINUM LOWER AND UPPER BODY:**  
lower weight – rigidity – friction reduction – longer component life.



**ULTRA-SHIFT™ EXCLUSIVE GEOMETRY PARALLELOGRAM:**  
maximum shifting rigidity, fast actuation, precision, friction reduction.

## FEATURES & BENEFITS



- **Holed cage plate for lower weight:** lighter
- **Special rubber pulleys:** reduced friction – less noise



CAMPAGNOLO® EXCLUSIVE TECHNOLOGIES:



248 g

**CENTAUR™ SPROCKET SET**

The profile of the teeth, completely redesigned in line with the Ultra-Drive™ project, makes it possible to achieve the maximum response speed at the moment of shifting. The synchronisation obtained by establishing a specific position of the teeth between sprocket and sprocket makes the passage from one sprocket to the next very fluid and fast. And in order not to lose rigidity, the last two are fitted on an aluminium frame.



**SPROCKET SYNCHRONIZATION:**

sprocket tuning is carefully designed to make shifting faster and more accurate – less chain stress.

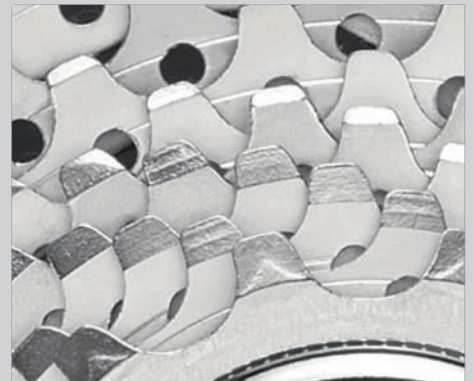

**ULTRA-DRIVE™ TEETH DESIGN:**

optimized upshifting.

**FEATURES & BENEFITS**



- **Nickel-Chrome surface treatment:** reduces chain/sprocket friction – extends sprockets' life

**Black & Red**

Clip-on version

92 g

**Deep Black**

## CENTAUR™ FRONT DERAILLEUR

Compact or traditional crankset?

The Centaur™ front derailleur can handle both solutions with no indecision. The M-Brace™ design of the front derailleur body and the inner arm in Z-Shape™ configuration ensure an unprecedented rigidity that translates into excellent shifting precision and speed.

## CAMPAGNOLO® EXCLUSIVE TECHNOLOGIES:



### SPECIAL INNER CAGE DESIGN:

greater rigidity - faster shifting - more space for the chain crossovers.



### DERAILLEUR BODY WITH EXCLUSIVE CAMPAGNOLO® M-BRACE™ GEOMETRY:

high system rigidity and shifting precision.

## FEATURES & BENEFITS

- **Outer cage anti-friction treatment:** reduces friction and extends components' life





2,36 g/link

## CHAIN CENTAUR™

The Centaur™ chain is incredibly quiet thanks to the Teflon wax treatment and the link-pin coupling geometry that reduces friction to the minimum, prolonging the life of the chain and ensuring less dispersion of the power transmitted. The precise sizing of links, rollers and pins reduces the interference with chainrings and sprockets adjacent to the ones in motion.

## CAMPAGNOLO® EXCLUSIVE TECHNOLOGIES:



**CHAIN LINK HD-LINK™ FASTENING SYSTEM:**  
excellent link locking – greater safety and longer chain life.

## FEATURES & BENEFITS

- **5.9mm special steel links:** prolongs chain life, reduces wear on gears and sprockets
- **Antifriction Ni-PTFE treatment:** reduced friction, smooth pedaling, quiet operation and greater efficiency – longer chain life

## CAMPAGNOLO® EXCLUSIVE TECHNOLOGIES:



**SPECIAL COMPOUND:**  
reduction of braking distance on both dry and wet surfaces – longer life for brake pad and rim.

## FEATURES & BENEFITS



- **Special design for forged aluminum brake arms:** greater bend resistance – lighter
- **Aluminum nuts:** less weight
- **Adjustable shoe holders:** shoe holders on rim's profile can be micro adjusted – longer life for rims and brake pads
- **Dual Pivot front/rear version:** enhanced rear braking



310 g

Black & Red

## CENTAUR™ BRAKES

Have no fear of going too fast. Safe stopping is assured by the Centaur™ brakes. The forged aluminium lever arms and their particular form provide an extremely high level of rigidity even in extreme situations. Combined with Campagnolo® brake pads and Ergopower™ brake levers, braking is absolutely safe and easily modulated for all situations, all this in just 310 grams!



John.  
875 mountain passes.  
The last one on his  
70th birthday.





SPEED

SPEED

CAMPAGNOLO

ATLANTA



372 g

Deep Black

Bright Silver

Carbon Finishing

Special colours upon request of bicycle manufacturers

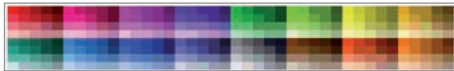

Colours available for hoods and casings



## ATHENA™ ERGOPOWER™ CONTROLS

Deep Black, Bright Silver, or if you like, with carbon finish: three alternatives for personalising your bike to the max. The performance features are top of the line thanks to Power-Shift™ technology which enables multiple upshifting (3 gears) and single downshifting. The strong points of the Athena controls are comfort and safety. The brake levers with double curvature and the hoods design based on the ergonomics of the hand make these controls the absolute benchmark on the market.

## CAMPAGNOLO® EXCLUSIVE TECHNOLOGIES:

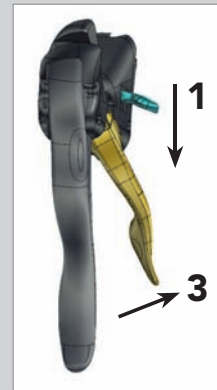

**POWER-SHIFT™ MECHANISM:** extremely fast and precise, it allows you to upshift by three sprockets at a time or downshift by one with just a single action.



**ULTRA-SHIFT™ ERGONOMICS:** ensures a firm grip on the handlebars and fast, precise control of the levers. The special ergonomic design makes it possible to assume three different hand positions on the levers compared to the two traditional ones.

**ERGONOMIC BRAKE LEVER:** lowered position of the fulcrum of the brake lever – reduces the stress of operating the brakes – greater braking modularity.



**VARI-CUSHION™ HOOD:** made of non-allergenic elastic material, with variable cushioning that provides the maximum comfort and safety even after many hours on the bike. Thanks to a special treatment, it is resistant to UV rays and maintains its original colours without fading.

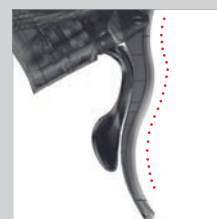

**DOUBLE CURVATURE BRAKE LEVER:** allows you to engage and modulate the brake safely from any hand position.

## FEATURES & BENEFITS

- **Insert for large hands:** greater safety and comfort for cyclists with large hands



**Deep Black**
**Bright Silver**

**Aluminium  
736 g**

**Carbon  
640 g**

## ATHENA™ CRANKSET

Aluminium or carbon fibre? Athena™ 11s gives you the freedom to choose the crankset configuration that best suits your bicycle. As always, its performance that's the strong point of Campagnolo® components. The extreme rigidity of cranks/chainrings and the Power Torque™ axle ensure the maximum efficiency of power transmission. It's the entry level 11-speed groupset with top-of-the-range features.

## CAMPAGNOLO® EXCLUSIVE TECHNOLOGIES:

### XIPES® EXTREME PERFORMANCE SHIFTING SYSTEM™



Exclusive design of the eight upshift zones and two downshift zones of the chainring. The specific profile of the teeth and the zones dedicated to upward and downward chain movement enable fast and precise shifting in all conditions.

### POWER TORQUE SYSTEM™



System with single axle designed to maximise stiffness and power transmission.



**NEW ATHENA™ 165mm CARBON CRANKSET:** it allows for an agile pedal stroke and a correct movement in relation to the length of the lower limbs.

## FEATURES & BENEFITS

- **Optimal positioning of the ball bearing seat:** reduces friction to the minimum, reduces mechanical stress, and protects the ball bearings from water and dust to assure consistent performance over time
- **Optimised U and Q factors:** space optimised between ankle and crank – maximum lateral and torsional stiffness

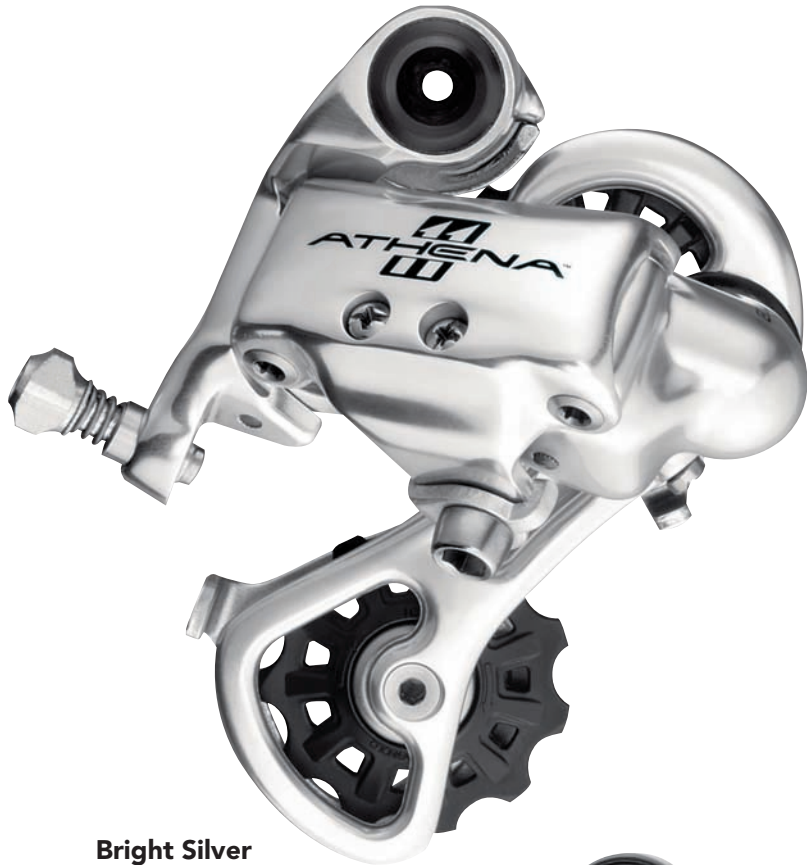

Bright Silver

209 g



Deep Black

## ATHENA™ REAR DERAILLEUR

Absolute precision.

The rear derailleur with Ultra Shift™ geometry is designed to give you the certainty of immediate shifting in all conditions.

The oversized outer plate wraps around the upper and lower bodies of the rear derailleur, providing superior stiffness. This translates into the absence of play and the maximum speed of chain movement upward and downward.

## CAMPAGNOLO® EXCLUSIVE TECHNOLOGIES:

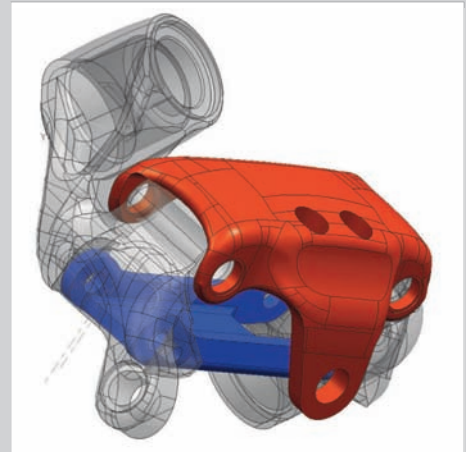

### ULTRA-SHIFT™ PARALLELOGRAM:

designed to wrap around the rear derailleur bodies and increase the overall stiffness of the rear derailleur. Makes shifting fast, precise, and clean in all conditions.

## FEATURES & BENEFITS



- **Lightened upper body:** weight reduction
- **Pulleys in special rubber:** friction reduction
- **Single cage version:** flexibility of use with all the sprocket combinations





230 g

## CHORUS™ SPROCKET SET

The Athena™ groupset uses the Chorus™ sprockets. The Campy Tech Lab™ engineers have designed each single tooth to assure optimal drive train engagement along with fast and precise shifting. The positioning of each sprocket has been designed to reduce friction to the maximum and make the pedal rotation silent and efficient. The six largest sprockets are mounted on separate frames, which increase their stiffness.

## CAMPAGNOLO® EXCLUSIVE TECHNOLOGIES:

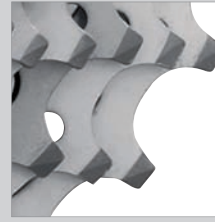

**ULTRA-SHIFT™ TEETH DESIGN:**  
every sprocket tooth is designed and placed to perform a specific function, such as raising or lowering the chain or giving maximum power transmission to the wheel.



**REINFORCED MOUNTS FOR SECOND AND THIRD TRIPLETS:**  
greater sprocket set rigidity – performance, precision.

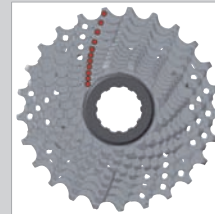

**ULTRA-SHIFT™ SYNCHRONIZATION:**  
sprocket tuning allows for maximum shifting performance without hesitation: fast, accurate, and quiet, even under stress.



2,24 g/link

## CHORUS™ CHAIN

You'll be amazed at its silence, fluidness, and durability. The Chorus™ 11s chain of 5.5mm width has been designed and constructed to guarantee riders the maximum in terms of safety and performance. The newly developed treated steel makes the links extremely resistant, and the Teflon surface treatment and Ultra-Link™ geometry make the chain smooth-running and highly durable.

## CAMPAGNOLO® EXCLUSIVE TECHNOLOGIES:

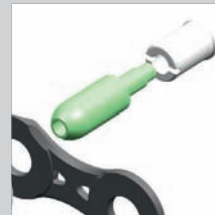

**ULTRA-LINK™ CHAIN CONNECTING SYSTEM:**  
high strength chain connection – greater safety and longer chain life.



**ULTRA-LINK™ CHAIN LINKS:**  
designed to give better performance to Campagnolo® drivetrains: greater durability of the gears and sprockets, maximum efficiency in the transmission of power.

## FEATURES & BENEFITS

- **Links made of special steel:** prolongs the life of the chain, reduces wear on chainrings and sprockets
- **Ni-PTFE™ anti-friction treatment:** reduces friction, makes pedal rotation smooth, silent, and efficient – longer chain life



Deep Black

92 g



Bright Silver

## ATHENA™ FRONT DERAILLEUR

Thanks to the Ultra-Shift™ geometry of the cage typical of all the Campagnolo® 11-speed groupsets, the chain can move between the gears of the crankset with the maximum speed and precision in any situation, even when “chain crossings” are extreme or under stress. The Athena™ front derailleur is compatible with both standard and compact cranksets.

### CAMPAGNOLO® EXCLUSIVE TECHNOLOGIES:



**OUTER CAGE WITH ULTRA-SHIFT™ DESIGN:**  
maximum cage stiffness – speed and precision of shifting.

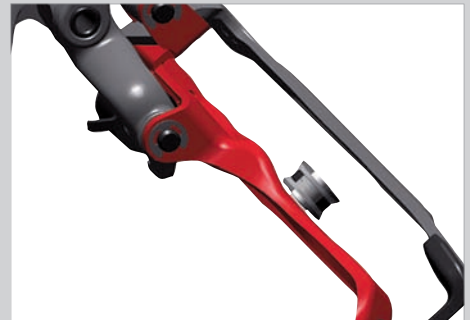

**SPECIAL INNER CAGE DESIGN:**  
greater rigidity - faster shifting - more space for the chain crossovers.



**EXCLUSIVE CAMPAGNOLO® FRONT DERAILLEUR BODY:**  
designed to make the system stiffer – improves the speed and precision of shifting.

### FEATURES & BENEFITS

- **Surface treatment:** reduces friction and prolongs the life of the component



**CAMPAGNOLO® EXCLUSIVE TECHNOLOGIES:**

**SKELETON BRAKE ARMS:**  
 no-bend arms, modularity, reduced weight.

**FRONT/REAR DIFFERENTIATED BRAKING:**  
 lighter rear brake – greater braking power modulation.

**SPECIAL BRAKE COMPOUND:**  
 better braking performance in all weather conditions – less wear on the braking track.

**Dual-Pivot version**  
**331 g (pair)**
**Deep Black**

**Mono/Dual Pivot version**  
**306 g (pair)**
**Bright Silver**

## ATHENA™ BRAKES

Campagnolo®'s objective is to provide both professional and amateur cyclists with the best braking system possible, adapted to their riding style. There are those who prefer to always have the maximum power available (dual pivot on the front and rear), and those, on the other hand, who prefer more controlled and modulated braking, with the monopivot in place of the dual on the rear brake.

## FEATURES & BENEFITS

- **Dual Pivot front/rear version:** enhanced rear braking



Stéphane\*.

Never leaves to go on tour  
without his group,  
his six-string, or his 11-speed.

\*Stéphane Sanseverino





STREET



337 g

Colours available for hoods and casings



Special colours upon request of bicycle manufacturers



## CHORUS™ ERGOPOWER™ CONTROLS

You can grasp the Chorus™ Ergopower™ controls any way you want: you'll always feel safe and responsive.

The ergonomic design of the Ergopower™ body enables you to grip the controls more firmly. The brake lever with double curvature and the classic double lever of the brake/shifter controls guarantee efficient braking in all conditions and easier operation.

## CAMPAGNOLO® EXCLUSIVE TECHNOLOGIES:



### ULTRA-SHIFT™ ERGONOMICS:

ensures a firm grip on the handlebars and fast, precise control of the levers. The special ergonomic design makes it possible to assume three different hand positions on the levers compared to the two traditional ones.

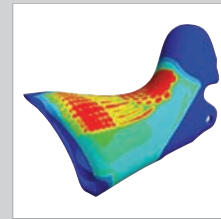

### VARI-CUSHION™ HOOD:

made of non-allergenic elastic material, with variable cushioning that provides the maximum comfort and safety even after many hours on the bike. Thanks to a special treatment, it is resistant to UV rays and maintains its original colours without fading.

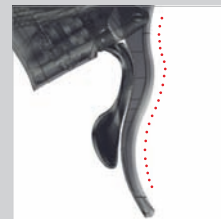

### DOUBLE CURVATURE BRAKE LEVER:

allows you to engage and modulate the brake safely from any hand position.

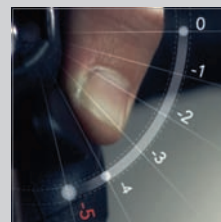

### EXCLUSIVE ULTRA-SHIFT™ MECHANISM:

with just one action of the lever, you can upshift by 1, 2 or 3 chainrings and downshift by 1 to 5 chainrings at a time.



## FEATURES & BENEFITS

- **Insert for large hands:** greater safety and comfort for cyclists with large hands
- **Bearing mechanism:** longer life – operating precision





667 g



**NEW 11-SPEED 165mm CRANKSET:**  
it allows for an agile pedal stroke and a correct movement in relation to the length of the lower limbs.

## CHORUS™ CRANKSET

X.P.S.S.™ (eXtreme Performance Shifting System) is the acronym that denotes the most effective and efficient system ever, with the absolute best shifting speed and precision even under load. The Chorus™ crankset with carbon fibre is the ideal partner for any competition.

## CAMPAGNOLO® EXCLUSIVE TECHNOLOGIES:

**X.P.S.S. EXTREME PERFORMANCE SHIFTING SYSTEM™**



Exclusive design of the eight upshift zones and two downshift zones of the chainring. The specific profile of the teeth and the zones dedicated to upward and downward chain movement enable fast and precise shifting in all conditions.

**ULTRA TORQUE™** 



**ULTRA-TORQUE™ BOTTOM BRACKET:**  
pressure on the pedals is transmitted efficiently without any loss of power.



**8 CHAIN UP SHIFT AND 2 CHAIN DOWNSHIFT ZONES:**  
faster and more precise shifting, even under stress.



**EXCLUSIVE CRANK/CHAINRING MOUNTING SYSTEM:**  
reduced weight – easy maintenance.



186 g

## CHORUS™ REAR DERAILLEUR

Chorus™ 11-speed's shifting precision is comparable to its older siblings Record™ and Super Record™.

The design and geometry of the rear derailleur are exactly the same. The only difference lies in the materials used, which made it possible to keep a favourable price without lowering the performance levels.

A groupset dedicated to competition like the Chorus™ 11-speed can't forego showing its true competitive spirit, and the carbon fibre front plate is the proof.

## CAMPAGNOLO® EXCLUSIVE TECHNOLOGIES:

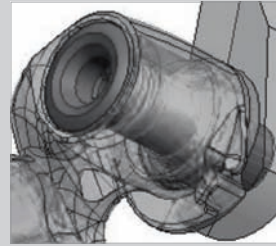

**REAR DERAILLEUR FIXING BOLTS IN ALUMINIUM:** with the same resistance and stiffness, the new two-part system makes it possible to reduce the weight by 53% compared to steel and 22% compared to titanium – prolongs the component life.



**CARBON FIBRE FRONT PLATE:** the body of the front plate wraps the upper and lower parts, providing 150% more torsional stiffness compared to a traditional rear derailleur.

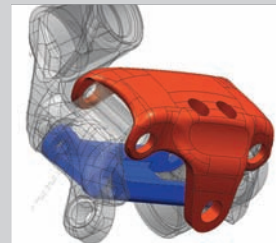

**ULTRA-SHIFT™ EXCLUSIVE GEOMETRY PARALLELOGRAM:** maximum derailleur stiffness, fast shifting, precision, reduction of possible play.



**ULTRA-SHIFT™ ALUMINIUM LOWER AND UPPER BODIES:** less weight, less friction, shifting precision.

## FEATURES & BENEFITS

- **Cage plate with holes for reducing weight:** lighter weight



## CAMPAGNOLO® EXCLUSIVE TECHNOLOGIES:

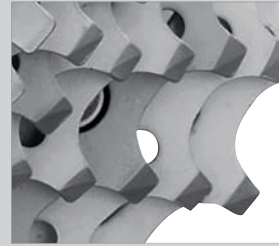

### ULTRA-SHIFT™ TEETH DESIGN:

every sprocket tooth is designed and placed to perform a specific function, such as raising or lowering the chain or giving maximum power transmission to the wheel.



### REINFORCED MOUNTS FOR SECOND AND THIRD TRIPLETS:

greater sprocket set rigidity – performance, precision.

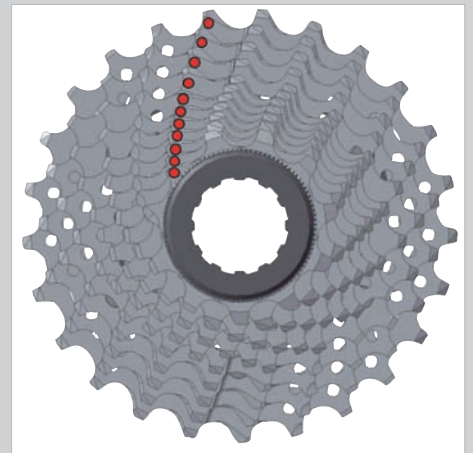

### ULTRA-SHIFT™ SYNCHRONIZATION:

sprocket tuning allows for maximum shifting performance without hesitation: fast, accurate, and quiet, even under stress.



230 g

## CHORUS™ SPROCKET SET

Every sprocket tooth has been designed to achieve the maximum synchronization, shifting speed, and silent operation.

The six larger sprockets have a double frame system for extreme torsional stiffness, so that operating precision is maintained even during shifting under stress.

The surface treatment of the eleven steel sprockets assures longer component life, maintaining the maximum performance through time.

## FEATURES & BENEFITS

- **Nickel-Chrome surface treatment:** reduces chain/sprocket friction – extends sprocket life



76 g

Braze-on version



## CHORUS™ FRONT DERAILLEUR

This system is fast, responsive, and precise, and the chain shifts across chainrings with no hesitations.

The Chorus™ 11-speed front derailleur is compatible with standard crank sets and the Compact™.

The geometry of the fork and the movement of the front plate have been designed and optimised to obtain maximum performance when used with the other Campagnolo® 2012 components.

## CAMPAGNOLO® EXCLUSIVE TECHNOLOGIES:



**ULTRA-SHIFT™ LIGHT ALLOY CAGE:** thanks to its graduated curvature shape, shifting is fast and extremely precise.

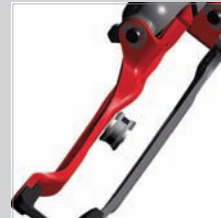

**SPECIAL INNER CAGE DESIGN:** greater rigidity - faster shifting - more space for the chain crossovers.



**EXCLUSIVE CAMPAGNOLO® FRONT DERAILLEUR BODY:** high system stiffness and shifting precision.

## FEATURES & BENEFITS

- **Outer anti-friction treatment:** reduces friction and extends the life of the component



2,24 g/link

## CHORUS™ CHAIN

Fluidity, smoothness, and noise reduction: the 5.5mm Chorus™ chain fully meets the quality and performance standards of the 11-speed™ groupsets.

The strength of the treated steel links is absolute, and the Ultra-Link™ closure system guarantees safety and the long life of the chain.

## CAMPAGNOLO® EXCLUSIVE TECHNOLOGIES:

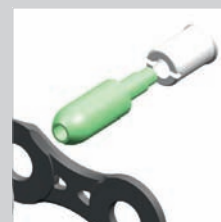

**ULTRA-LINK™ CHAIN CONNECTING SYSTEM:** high strength chain connection – greater safety and longer chain life.



**ULTRA-LINK™ CHAIN LINKS:** designed to give better performance to Campagnolo® drivetrains - greater durability of the gears and sprockets, maximum efficiency in the transmission of power.

## FEATURES & BENEFITS

- **Links made of special steel:** prolongs the life of the chain, reduces wear on chainrings and sprockets
- **Ni-PTFE™ anti-friction treatment:** reduces friction, makes pedal rotation smooth, silent, and efficient – longer chain life





**Dual-Pivot  
version**

**319 g (pair)**



**Mono/Dual Pivot  
version**

**299 g (pair)**

## CHORUS™ BRAKES

The compounds used yield superior braking performance and the lightened pad holders make pad replacement fast and easy. But that's not all. Campagnolo® offers two options: alongside the classic front/rear brake differentiation for maximum lightness and braking modulation, there is also a dual pivot option available for the rear brake, for even more decisive and powerful braking. The choice is yours!

## CAMPAGNOLO® EXCLUSIVE TECHNOLOGIES:

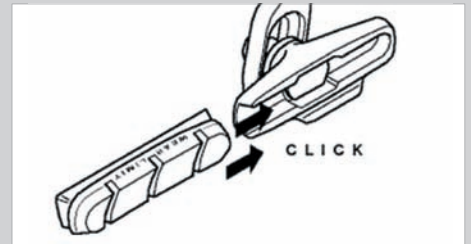

### EXCLUSIVE BRAKE PAD COUPLING/UNCOUPLING SYSTEM:

fast and secure brake pad replacement.



### SPECIAL COMPOUND:

reduction of braking distance in both dry and wet conditions – longer brake pad and braking track life.



### SKELETON BRAKE ARMS:

no-bend arms, modularity, reduced weight.



### FRONT/REAR DIFFERENTIATED BRAKING:

lighter rear brake – greater braking power modulation

## FEATURES & BENEFITS

- **Lighter pad holders:** reduced weight
- **Dual Pivot front/rear version:** enhanced rear braking



Andrew.

Today he climbed the Mortirolo  
34 seconds faster.



OLIO

RECORD



S



337 g

Colours available for hoods and casings



Special colours upon request of bicycle manufacturers



## CAMPAGNOLO® EXCLUSIVE TECHNOLOGIES:



### ULTRA-SHIFT™ ERGONOMICS:

ensures a firm grip on the handlebars and fast, precise control of the levers. The special ergonomic design makes it possible to assume three different hand positions on the levers compared to the two traditional ones.

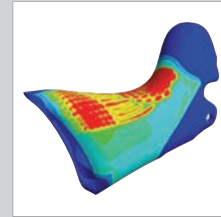

### VARI-CUSHION™ HOOD:

made of non-allergenic elastic material, with variable cushioning that provides the maximum comfort and safety even after many hours on the bike. Thanks to a special treatment, it is resistant to UV rays and maintains its original colours without fading.

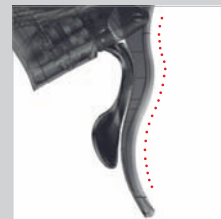

### DOUBLE CURVATURE BRAKE LEVER:

allows you to engage and modulate the brake safely from any hand position.

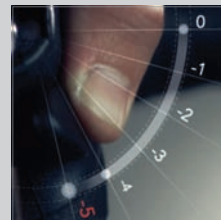

### EXCLUSIVE ULTRA-SHIFT™ MECHANISM:

with just one action of the lever, you can upshift by 1, 2 or 3 chainrings and downshift by 1 to 5 chainrings at a time.



## RECORD™ ERGOPOWER™ CONTROLS

It's all in your hands. From any position on the handlebars, the ergonomics of ErgoPower™ controls enable you to engage the rear derailleur and front derailleur with extreme speed and precision. The maximum in performance while safety and comfort are not to be neglected: every detail is designed to provide the maximum comfort even after long hours on the bike.

## FEATURES & BENEFITS

- **New material of the control body:** the new material makes the ErgoPower™ controls both extremely light and resistant to impact
- **Double hole brake lever:** lighter
- **Insert for larger hands:** safer and more comfortable for larger hand riders
- **Bearing mechanism:** longer life – operating precision



## CAMPAGNOLO® EXCLUSIVE TECHNOLOGIES:

### XPSS™ EXTREME PERFORMANCE SHIFTING SYSTEM™



Exclusive design of the eight upshift zones and two downshift zones of the chainring. The specific profile of the teeth and the zones dedicated to upward and downward chain movement enable fast and precise shifting in all conditions.

### ULTRA TORQUE™

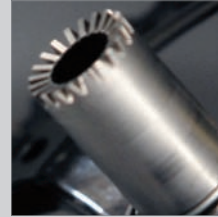

**ULTRA-TORQUE™ BOTTOM BRACKET:** pressure on the pedals is transmitted efficiently without any loss of power.

### UHS™ ULTRA-HOLLOW™ STRUCTURE



**HOLLOW CRANKS AND SPIDER ARMS WITH ULTRA-HOLLOW™ TECHNOLOGY:** reduces weight of stress – free areas, improves crank set weight and rigidity ratio.

### USB™ CERAMIC ULTRA SMOOTH BEARINGS



**USB™ TECHNOLOGY:** USB™ ceramic ball bearings reduce friction, guaranteeing the maximum smoothness. Resistant to corrosion and wear, they maintain consistent performance over time.

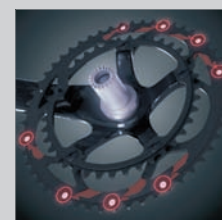

**8 CHAIN UP SHIFTING AREAS AND 2 CHAIN DOWNSHIFTING AREAS:** faster and more precise shifting, even under stress.



**INTEGRATED CRANK/CHAINRING MOUNTING SYSTEM:** reduced weight – easy maintenance.

## FEATURES & BENEFITS

- **Lighter bottom bracket:** lighter



627 g



**NEW 11-SPEED 165mm CRANKSET:** allows for an agile pedal stroke and a correct movement in relation to the length of the lower limbs.

## RECORD™ CRANKSET

An extra weapon for achieving victory.

The Record™ crankset is designed to transmit 100% of the cyclist's power to the wheel: maximum torsional stiffness of the system, the best U and Q factors in the category, and cranks made entirely of unidirectional carbon fibre.

But the real surprise comes with the first shift: precise, extremely fast, and with no hesitation, thanks to the design of the upshifting and downshifting zones of the XPSS™ chainrings. Shifting is no longer a problem, not even under extreme conditions.



172 g

## RECORD™ REAR DERAILEUR

It's the heart and soul of the Record™ 11s drivetrain! The Record™ rear derailleur has always evoked competitions and wins, and still today represents for professional racers the certainty of fast and extremely precise shifting, even under load. But you don't have to be a pro to take advantage of the performance features of the Record™ 11-speed: the fun is for all.

## CAMPAGNOLO® EXCLUSIVE TECHNOLOGIES:

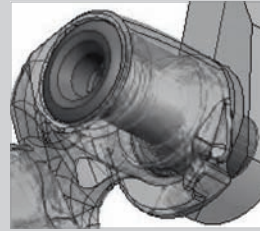

**ALUMINIUM REAR DERAILEUR FASTENING SCREWS:** the two-piece system, while maintaining resistance and rigidity, makes it possible to reduce the weight by 53% compared to steel and 22% compared to titanium, and prolongs the life of the component.



**CARBON FIBRE FRONT PLATE:** extreme stiffness and reduced weight. Increases the precision of the rear derailleur.

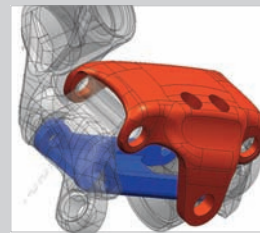

**ULTRA-SHIFT™ EXCLUSIVE GEOMETRY PARALLELOGRAM:** maximum shifting rigidity, fast actuation, precision, friction reduction.



**ULTRA-SHIFT™ ALUMINUM LOWER AND UPPER BODIES:** less weight, less friction, shifting precision.

## FEATURES & BENEFITS

- **Carbon fiber cage plate:** shifting positioning is extremely accurate and extremely light
- **Ceramic ball bearings:** considerably smooth, they reduce friction and prolong life and shifting performance



## CAMPAGNOLO® EXCLUSIVE TECHNOLOGIES:



### ULTRA-SHIFT™ TEETH DESIGN:

every sprocket tooth is designed and placed to perform a specific function, such as raising or lowering the chain or giving maximum power transmission to the wheel.



### REINFORCED MOUNTS FOR SECOND AND THIRD TRIPLETS:

greater sprocket set rigidity – performance, precision.

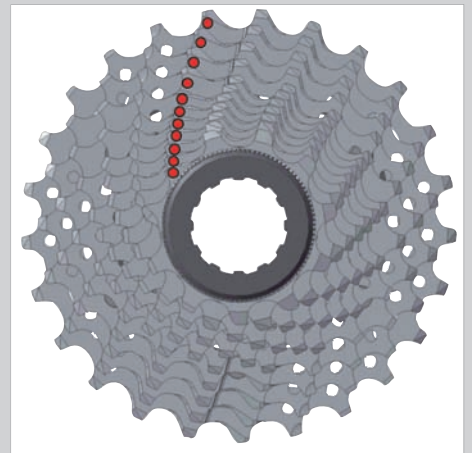

### ULTRA-SHIFT™ SYNCHRONIZATION:

sprocket tuning allows for maximum shifting performance without hesitation: fast, accurate, and quiet, even under stress.



201 g

## RECORD™ SPROCKET SET

In competition every little detail counts; that's why steel and titanium were used when producing Record™ sprockets.

The perfect teeth design results in a perfect synchronization between shifting and chain movement.

The six larger sprockets are divided in triplets, which are mounted on special frames to increase rigidity.

## FEATURES & BENEFITS

- **3 titanium sprockets:** less weight



74 g

Clip-on version



## RECORD™ FRONT DERAILLEUR

This is the component that, together with the chainrings and chain, assures the exceptional shifting of the Record™ groupset. Ultra-Shift™ geometry makes the cage extremely rigid, while the body and frame attachment systems make this front derailleur precise, fast, and hesitation-free.

## CAMPAGNOLO® EXCLUSIVE TECHNOLOGIES:

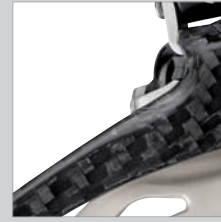

**ULTRA-SHIFT™ CARBON OUTER CAGE:**  
thanks to its graduated curvature, shifting is fast and extremely precise.

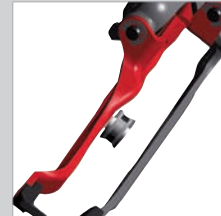

**SPECIAL INNER CAGE DESIGN:**  
greater rigidity - faster shifting - more space for the chain crossovers.



**EXCLUSIVE CAMPAGNOLO® GEOMETRY DERAILLEUR:**  
high system rigidity and shifting precision.

## FEATURES & BENEFITS

- **Outer anti-friction treatment:** reduces friction and extends component's life



2,10 g/link

## RECORD™ CHAIN

Pros are the everyday testing ground for the chain fitted on all advanced Record™ 11 and Super Record™ 11 groups. Links and pins have been designed to adhere perfectly to gears and sprockets teeth providing maximum fluidity, reduced friction and improved chain life.

## CAMPAGNOLO® EXCLUSIVE TECHNOLOGIES:

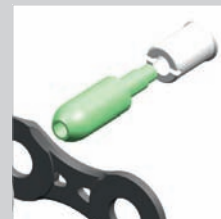

**CHAIN LINK ULTRA-LINK™ CONNECTING SYSTEM:**  
high strength chain connection - greater safety and longer chain life.



**ULTRA-LINK™ CHAIN LINKS:**  
designed to provide the best possible performance for Campagnolo® transmissions – longer life for gears and sprockets, maximum efficiency in power transmission.

## FEATURES & BENEFITS

- **Special steel links:** prolongs chain life, reduces wear on gears and sprockets
- **Antifriction Ni-PTFE treatment:** reduces friction and makes the ride smooth and quiet. It prolongs chain life





**Dual-Pivot  
version**  
303 g (pair)



**Mono/Dual Pivot  
version**  
278 g (pair)

## RECORD™ BRAKES

Following professional cyclists means meeting all their needs. This is why Campagnolo® has designed two Record™ brake options. An extra pivot has been added to the standard single pivot rear version for those who want an immediate and decisive brake response. Braking power results from both our Skeleton design and the new brake shoe combination. The shoe holder allows for better regulation and helps to improve the friction surface.

## CAMPAGNOLO® EXCLUSIVE TECHNOLOGIES:



**LIGHTER SHOE HOLDERS:**  
less weight.



**CENTRAL FULCRUM WITH BEARING SYSTEM:**  
braking modulation, reliability, and performance consistently maintained over time.

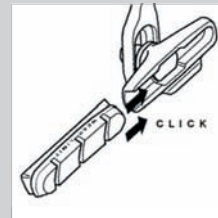

**EXCLUSIVE BRAKE PAD COUPLING/UNCOUPLING SYSTEM:**  
fast and secure brake pad replacement.

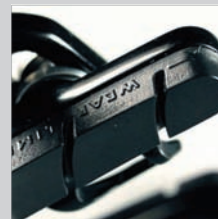

**SPECIAL COMPOUND:**  
reduction of braking distance in both dry and wet conditions – longer brake pad and braking track life.

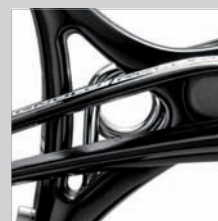

**SKELETON BRAKE ARMS:**  
no-bend arms, modularity, reduced weight.

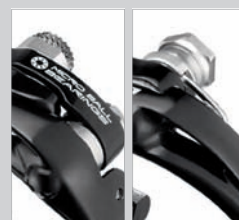

**FRONT/REAR DIFFERENTIATED BRAKING:**  
lighter rear brake – greater braking power modulation.

## FEATURES & BENEFITS

- **Dual Pivot front/rear version:** enhanced rear braking



Albert.

He thinks to himself:  
almost 8000 miles this year  
and how many times  
did I change gears?



SUPER RECORD

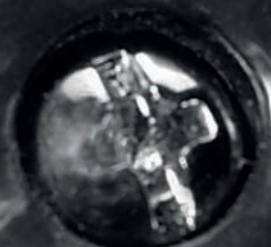



330 g

Colours available for hoods and casings



Special colours upon request of bicycle manufacturers



## SUPER RECORD™ ERGOPOWER™ CONTROLS

Dominate your bike at every turn, relax on the long straights, and prepare for the final sprint: whatever your racing position, Ergopower™ controls, with the exclusive Campagnolo® mechanism allows you to shift up 3 sprockets at a time and down 5 sprockets. Make every movement natural, fast and precise.

The Ergopower™ Ultra-Shift™ controls of the Super Record™ series represent the top of the line in terms of technology applied to the ergonomics of the hand – all to the advantage of safety, speed and precision in the controls. Your every wish is a command.

## CAMPAGNOLO® EXCLUSIVE TECHNOLOGIES:



### ULTRA-SHIFT™ ERGONOMICS:

safe grip on handlebars in all positions and faster, more precise command on levers.

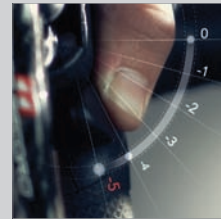

### EXCLUSIVE ULTRA-SHIFT™ MECHANISM:

with just one action of the lever, you can upshift by 1, 2 or 3 chainrings and downshift by 1 to 5 chainrings at a time.

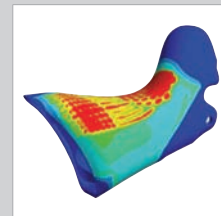

### VARI-CUSHION™ HOOD:

made of non-allergenic elastic material, with variable cushioning that provides the maximum comfort and safety even after many hours on the bike. Thanks to a special treatment, it is resistant to UV rays and maintains its original colours without fading.

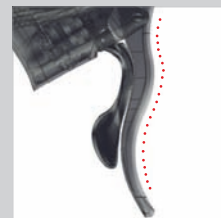

### DOUBLE CURVATURE BRAKE LEVER:

allows you to engage and modulate the brake safely from any hand position.

## FEATURES & BENEFITS

- **New material of the control body:** the new material makes the Ergopower™ controls both extremely light and resistant to impact
- **Triple hole break lever:** lighter
- **Titanium finishing:** less weight
- **Insert for larger hands:** safer and more comfort for cyclists with larger hands
- **Bearing mechanism:** longer life – operating precision



**CAMPAGNOLO® EXCLUSIVE TECHNOLOGIES:**

**XIPIS EXTREME PERFORMANCE SHIFTING SYSTEM™**



Special design of chain up and downshift zones – chainring pin profile optimization – allows for faster and more precise shifting in all conditions.

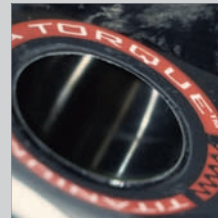

**TITANIUM AXLE (OPTIONAL) AND REVERSE THREAD TITANIUM FIXING BOLT:** reduces the overall weight of the crankset by 40 grams.



**CERAMIC ULTIMATE LEVEL TECHNOLOGY**  
MAXIMUM SMOOTHNESS FOR MAXIMUM PERFORMANCE

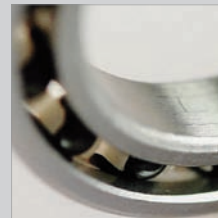

The combination of the best ceramic balls available on the market and special Cronitect™ steel. The bearings are lubricated with only a film of oil, increasing the smoothness of the crank nine-fold. Resistant to corrosion – performance unaltered over time.

**UHS ULTRA-HOLLOW™ STRUCTURE**



**HOLLOW CRANKS AND SPIDER ARMS WITH ULTRA-HOLLOW™ TECHNOLOGY:** reduced weight of stress – free sections, improved crank set weight to stiffness ratio.

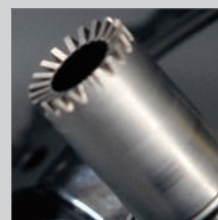

**ULTRA-TORQUE™ BOTTOM BRACKET:** pressure on the pedals is transmitted efficiently without any power loss.

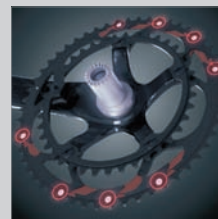

**8 CHAIN UP SHIFT ZONES, AND 2 CHAIN DOWNSHIFT ZONES:** faster and more precise shifting, even under stress.

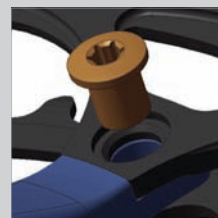

**EXCLUSIVE CRANK/ CHAINRING MOUNTING SYSTEM:** reduced weight – easy maintenance.



**625 g**



**585 g with Titanium axle**

**NEW 11-SPEED 165mm CRANKSET:** allows for an agile pedal stroke and a correct movement in relation to the length of the lower limbs.

**SUPER RECORD™ CRANKSET**

The maximum that you could ask for in performance and smoothness. The Super Record™ crankset is an extraordinary concentration of technology and performance: extremely high overall stiffness, extraordinary lightness, fast and precise shifting; the CULT™ system and the option with titanium axle, all this enhances even more the performance and uniqueness of this crankset.



155 g

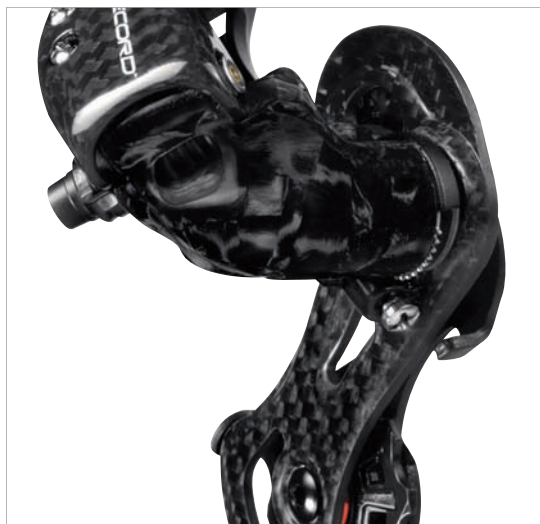

## SUPER RECORD™ REAR DERAILLEUR

The masterpiece of the 2012 range!  
 Speed, precision, smoothness and better looks: the first rear derailleur with carbon fibre upper and lower body will amaze even the most demanding of cyclists. Lower and upper bodies, outer plate, parallelogram: all carbon-made components. The white "11" on a red rectangle printed on the carbon fibre makes the image of the Super Record™ rear derailleur even more unique and aggressive.

## CAMPAGNOLO® EXCLUSIVE TECHNOLOGIES:

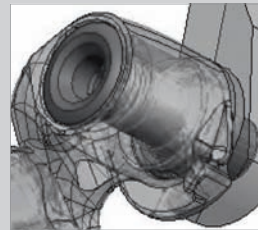

### ALUMINUM FIXING BOLT:

the new two-part system is 53% lighter than steel and 22% lighter than titanium, without compromising resistance and rigidity levels and prolonging component life.



### CARBON FIBRE UPPER AND LOWER BODY:

extreme rigidity and reduced weight. It increases rear derailleur precision and prolongs the life of component.



### CARBON FIBER CAGE PLATE:

shifting positioning is exceedingly precise – extremely light.

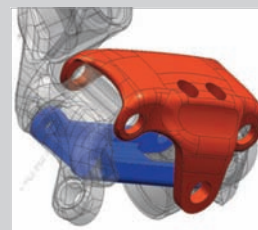

### CARBON FIBER PARALLELOGRAM, AND EXCLUSIVE ULTRA-SHIFT™ GEOMETRY:

maximum shifting rigidity, fast actuation, precision, friction reduction.

## FEATURES & BENEFITS

- **Ceramic ball bearings:** very smooth, reduces friction, prolongs life and shifting performance
- **Pulley cage aluminum fixing bolts:** lighter



**CAMPAGNOLO® EXCLUSIVE TECHNOLOGIES:**



**ULTRA-SHIFT™ TEETH DESIGN:**  
every sprocket tooth is designed and placed to perform a specific function, like lifting or lowering the chain or giving maximum power transmission to the wheel.



**REINFORCED MOUNTS FOR SECOND AND THIRD TRIPLETS:**  
greater sprocket set rigidity – performance precision.



**ULTRA-SHIFT™ SYNCHRONIZATION:**  
the sprocket tuning allows for maximum shifting performance without hesitation: fast, precise and quiet, even under stress.



**6 TITANIUM SPROCKETS:**  
less weight.

**FEATURES & BENEFITS**

- **Nickel-Chrome surface treatment:** reduces chain/sprocket friction – extends sprockets' life



177 g



**SUPER RECORD™ SPROCKET SET**

Maximum performance and low noise with no compromise on components. With this in mind Campagnolo® engineers designed our Super Record™ sprockets with double frame on the last two sprocket triplets.

This results in a more solid and lighter frame, thanks to the use of titanium in the 6 larger sprockets.

The Ultra-Shift™ teeth design has been upgraded to make shifting faster, with perfect synchronization and to eliminate chain stress.



72 g

Braze-on version



## SUPER RECORD™ FRONT DERAILLEUR

Absolutely unrivalled precision and speed: the Super Record™ front derailleur with Ultra Shift™ geometries combined with the Campagnolo® crankset and chain guarantee the best of shifting performance under any condition.

## CAMPAGNOLO® EXCLUSIVE TECHNOLOGIES:



### ULTRA-SHIFT™ CARBON CAGE:

thanks to its graduated curvature, shifting is fast and extremely precise.

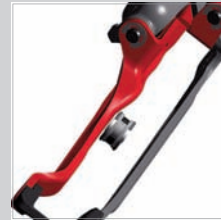

### SPECIAL INNER CAGE DESIGN:

greater rigidity - faster shifting - more space for the chain crossovers.

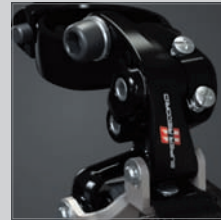

### EXCLUSIVE CAMPAGNOLO® GEOMETRY DERAILLEUR:

high system rigidity and shifting precision.



2,10 g/link

## RECORD™ CHAIN

All your power is transmitted by the transmission component: the chain. Super Record™ groupsets include Record™ chains: fast, long-lasting and safe.

Links and pins have been designed to adhere perfectly to the teeth of chainrings and sprockets to reduce friction.

There is no power loss and component life is extended.

## CAMPAGNOLO® EXCLUSIVE TECHNOLOGIES:

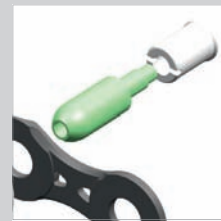

### ULTRA-LINK™ CHAIN LINK CONNECTING SYSTEM:

high strength chain connection – greater safety and longer chain life.



### ULTRA-LINK™ CHAIN LINKS:

designed to provide maximum performance to Campagnolo® transmissions: longer life for chainrings and sprockets, maximum efficiency in power transmission.

## FEATURES & BENEFITS

- **Special steel links:** prolongs chain life, reduces chainrings and sprocket wear
- **Antifriction Ni-PTFE™ treatment:** reduces friction, smooth pedaling, quiet operation and efficiency – prolongs chain life





**Dual-Pivot version**  
297 g (pair)



**Mono/Dual Pivot version**  
272 g (pair)

## SUPER RECORD™ BRAKES

For a fast descent you need a safe and reliable braking system that is powerful and adjustable. The Super Record™ system guarantees shorter braking distance and complete control of breaking power thanks to our Skeleton arm design and new brake pads.

In its standard version Campagnolo® offers the classic front brake Dual Pivot and rear brake Mono Pivot design to provide maximum braking power modulation. But for those looking for the maximum braking power, even at the rear, Campagnolo® offers the rear brake Dual Pivot option.

## CAMPAGNOLO® EXCLUSIVE TECHNOLOGIES:



**LIGHTER SHOE HOLDERS:**  
lighter.

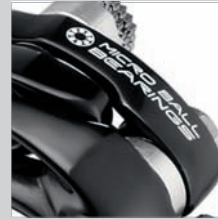

**CENTRAL FULCRUM WITH BEARING SYSTEM:**  
braking modulation, reliability, and performance consistently maintained over time.

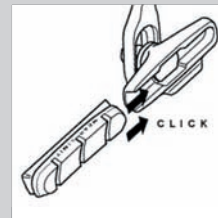

**EXCLUSIVE BRAKE PAD COUPLING/UNCOUPLING SYSTEM:**  
fast and secure brake pad replacement.

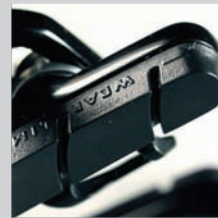

**SPECIAL COMPOUND:**  
reduction of braking distance in both dry and wet conditions – longer brake pad and braking track life.

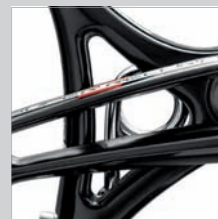

**SKELETON BRAKE ARMS:**  
no-bend arms, modularity, reduced weight.

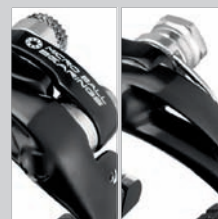

**FRONT/REAR DIFFERENTIATED BRAKING:**  
lighter rear brake – greater braking power modulation.

## FEATURES & BENEFITS

- **Dual Pivot front/rear version:** enhanced rear braking



Carlo.  
Can spend days on a detail  
to gain even just one second.





## TIME TRIAL / TRIATHLON COMPONENTS

Running against time and winning.

Attention to the smallest detail, the most aerodynamic position, the efficient transmission of power to the wheel: this is the only way to "shave off" every 10th of the second and reach the goal of the podium.

To give you all of this Campagnolo® has designed and developed, in collaboration with the best Triathlon and Time Trial athletes, the range dedicated to these disciplines: new Bar-End controls for 10 and 11-speed systems, brake controls and cranksets: That is everything that, along with the range of high-profile wheels and Campagnolo® groupsets, will prepare your bike to cut through the air and ride fast towards the finish line.



167 g

Carbon  
155 g

Versions available:  
11-Speed with carbon fibre or aluminium levers  
10-Speed with aluminium levers



## BAR-END CONTROLS

Designed in the hands of the athletes. Every single detail has been designed and tested by professional athletes. Obsessed with details, extremely attentive to the riding position and to saving energy, they are the true stars of the development of this product.

The Campy-Tech Lab™ has turned this information in a reality: the "Back to Zero position" system allows the lever to maintain an optimal position with respect to airflow and allows for less effort for the athlete. The "Multi-Shifting System" allows, with just one movement, to shift up or down up to 3 cogs at a time!

But to fully appreciate all the benefits that the Campagnolo® controls offer, you need to get on the saddle, place your hands and go to beat the clock.

## CAMPAGNOLO® EXCLUSIVE TECHNOLOGIES:

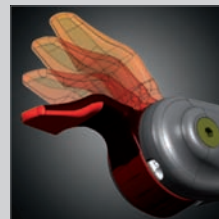

### BACK-TO-ZERO POSITION:

it allows the lever to maintain the initial position selected by the athlete. It reduces the effort required to shift it and to keep the lever in a position of maximum aerodynamic efficiency.



### ADJUSTABLE INITIAL POSITION:

it allows you to place the controls in a fully ergonomic position with respect to the shape of the handlebar and the personal position of the hands.

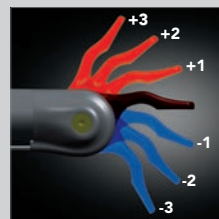

### MULTI-SHIFTING SYSTEM™:

possibility to shift up or down up to 3 cogs at a time.

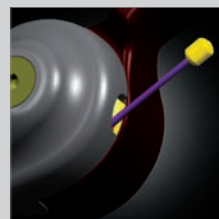

### EXTERNAL CABLE CONNECTION:

cables are easy to install and remove – there is no need to remove the controls.

## FEATURES & BENEFITS

- **Levers with double hand/finger positions:** minimises the effort of moving the levers – provides the best aerodynamic position even during shifting
- **Micrometric adjustment of the front derailleur:** it maintains the optimal position of the front derailleur with respect to the chain line even during the race
- **Optimisation of the lever movement load:** reduces the effort needed to operate the rear and front derailleur maintaining the typical "click feeling" of Campagnolo's drivetrain



## TT/TRIATHLON

### CAMPAGNOLO® EXCLUSIVE TECHNOLOGIES:



**AERODYNAMIC PROFILE:**  
maximum aerodynamic coefficient.



**ERGONOMIC PROFILE FOR THE LEVERS:**  
maximum safety and adjustable braking system.



**QUICK-RELEASE SYSTEM:**  
it makes it easier to install and remove the wheel and allows, even during the race, to open the distance between the rim and the brake pads.



106 g



**Carbon**  
86 g

## BAR-END BRAKE LEVERS

Care for detail in every component.

This is why the new Campagnolo® levers for Bar End are not just simple levers! In a discipline where each second becomes decisive, the difference with the competitors is to be found in the individual detail.

Designed and tested in our wind tunnel and developed on the road with professional athletes, they are designed with the aim of following the movements of your hand and allow the best aerodynamic position even when operating them.

Athletes that run against the clock are well aware of how important perfection is. And Campagnolo® is sure to give you what you are looking for.

## FEATURES & BENEFITS

- **Technopolymer body:** lightness and extreme resilience against collisions
- **Double version:** 2 choices of material – carbon fibre or aluminium



**Super Record™**  
with Titanium axle  
675 g

## TT CRANKSETS WITH GEARS 55/42 – 54/42

Super Record™ – Record™ – Chorus™

Technology and performance dedicated to time-trial and Triathlon professionals.

The “55 and 54” are second to none: You need to know how to push higher gears without hesitation. But one thing is certain: The Campagnolo® cranksets are designed to transmit all of the cyclist’s power, without losing even one Watt.

Shifting is extremely fast and accurate, the smoothness and fluidity of the pedal stroke is insured by the USB™ ceramic ball (for Super Record™ and Record™) and the carbon fibre cranks allow for maximum rigidity of the system.



## TT/TRIATHLON

CAMPAGNOLO® EXCLUSIVE TECHNOLOGIES:



757 g

**CHORUS**  
11



**GEAR COMBINATIONS 55/42 – 54/42:**

Dedicated to all those using it at a professional/competition level, the new cranksets with dedicated gears allow for considerable metric improvements.



718 g

**RECORD**



**NEW GEARS GEOMETRY:**

maximum torsional and lateral rigidity – the special geometry of the gears keeps the same value of stiffness of the gears with 53 toothing.



715 g

**SUPER RECORD**



Filippo.  
Has chosen cyclocross because  
it gives much more pleasure  
to reach the first place  
on the podium starting from  
the mud.





## COMPONENTS AND WHEELS FOR CYCLOCROSS

**MUD, SAND, WATER, TOIL, AND SWEAT.  
IN CYCLOCROSS YOU HAVE TO LEARN TO LIVE WITH THESE ELEMENTS THAT MAKE EVERY RIDE  
EXTREMELY TOUGH AND DEMANDING.**

These rules are proven for the riders, but even more so for the components and wheels!

This is why every ounce of experience acquired by the Campagnolo® engineers has been poured into the range dedicated to this difficult sport, making the components more resistant and reliable even in the most extreme climate and terrain conditions.

Mud and dust are no longer a concern, because the wheels and cranksets are equipped with special seals that close the door to all external contaminants. So the bearings consistently do their best work, allowing the Cyclocross wheels to assure the maximum smoothness even after many hours of use in extreme conditions. Spokes, hubs, and lacing patterns are a guarantee of stability even in the presence of violent stresses.

But that's not all. The Campy Tech Lab™ engineering staff conducted in-depth studies on the behaviour of the chain on the chainrings during shifting in the most critical situations, leading to some very important results. The inner machining of the chainrings was created to facilitate the up shift and downshift of the chain, so that the movements are fast and precise in all conditions.

First in the laboratory, then directly in the field, the Campagnolo® components and wheels passed with flying colours, all the extremely rigorous tests performed on them. Now it's your turn to put them to the test!



629 g

## CX 10 CRANKSET POWER TORQUE SYSTEM™ IN CARBON FIBRE

The athletes who field-tested the CX 10 crankset in carbon fibre did not hold back.

Campagnolo® realised all their needs by optimising the dimensions and spacing of the chainrings. Mud is no longer a problem.

The Campy Tech Lab™ engineers applied the same asymmetrical design to the teeth as our 11s systems, which have shown very low friction values and an incredibly high operating precision.

The chainrings are in aluminium with the chain up shift and downshift zones specifically designed for Cyclocross.

## CAMPAGNOLO® EXCLUSIVE TECHNOLOGIES:

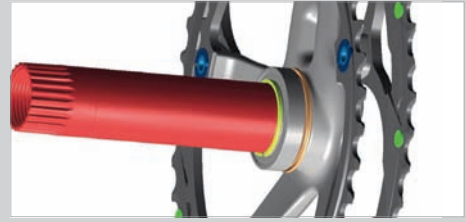

**SPECIALLY-DESIGNED DOUBLE-LIP SEAL FOR CX:**  
ensures that the mechanical parts (balls/bearings) subjected to the extreme conditions of Cyclocross stay clean, smooth-running and durable.

**CART** CYCLOCROSS ADVANCED RACING TECHNOLOGY™



**C.A.R.T. CYCLOCROSS ADVANCED RACING TECHNOLOGY™:**  
chainrings for Campagnolo® 10-speed groupsets developed specifically for Cyclocross use – efficiency in all conditions of use.



**CHAIN UP SHIFT AND DOWNSHIFT ZONES SPECIALLY DESIGNED FOR CYCLOCROSS:**  
fast shifting even in critical situations due to rough terrain or the presence of mud on the chainrings.

**POWER TORQUE SYSTEM**™



**POWER TORQUE SYSTEM™ BOTTOM BRACKET WITH SPECIAL SEALS FOR CYCLOCROSS:**  
reduced U-factor and Q-factor – durability over time even in extreme use and in difficult conditions.

## FEATURES & BENEFITS

- **Carbon fibre cranks:** light weight and high stiffness to torsion and flexion/ enable efficient power transmission
- **Black anodised finish of the chainrings:** greater protection of the exposed parts and aesthetics in line with the crank in carbon fibre
- **Combinations: 50-34 and 46-36:** developed and optimised for Cyclocross



CX 10

## CAMPAGNOLO® EXCLUSIVE TECHNOLOGIES:

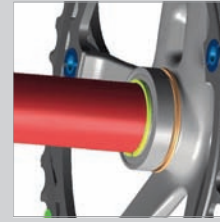

### SPECIALLY-DESIGNED DOUBLE-LIP SEAL FOR CX:

ensures that the mechanical parts (balls/bearings) subjected to the extreme conditions of Cyclocross stay clean, smooth-running and durable.

CART CYCLOCROSS ADVANCED RACING TECHNOLOGY™



### C.A.R.T. CYCLOCROSS ADVANCED RACING TECHNOLOGY™:

chainrings for Campagnolo® 10-speed groupsets developed specifically for Cyclocross use – efficiency in all conditions of use.

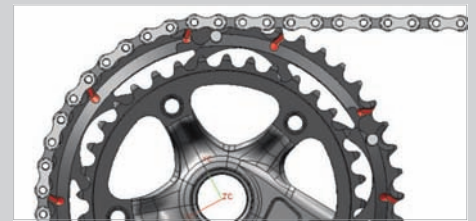

### CHAIN UP SHIFT AND DOWNSHIFT ZONES SPECIALLY DESIGNED FOR CYCLOCROSS:

fast shifting even in critical situations due to rough terrain or the presence of mud on the chainrings.

POWER TORQUE SYSTEM™



### POWER TORQUE SYSTEM™ BOTTOM BRACKET WITH SPECIAL SEALS FOR CYCLOCROSS:

reduced U-factor and Q-factor – durability over time even in extreme use and in difficult conditions.

## FEATURES & BENEFITS

- **Aluminium crank/chainrings:** ensures considerable stiffness and long life. The teeth of the chainrings and the up shift/downshift zones are designed for use in extreme conditions
- **Combinations: 50-34 and 46-36:** developed and optimised for Cyclocross



731 g

## CX 10 CRANKSET POWER TORQUE SYSTEM™

Campagnolo® has set a new standard for Cyclocross. The aluminium crankset developed for all the 10-speed groupsets uses chainrings dedicated to off-road.

The optimised design of the teeth and of the chain up shift/downshift zones ensures the maximum performance even in the most extreme conditions.

The high-protection seals for the Power Torque System™ bottom bracket make the bearings extremely smooth and maintain performance over time.



628 g

## CX 11 CRANKSET POWER TORQUE SYSTEM™ IN CARBON FIBRE

Are you a Cyclocross professional or, do you require the absolute best performance from your bike? Then you've got to have the CX 11 carbon fibre crankset on your bike. You'll recognise it by the special graphics and you'll appreciate the chainring combinations of 46-36 or 34-50 teeth.

The design of the teeth and the up shift and downshift zones for the 11-speed drivetrain is the maximum anyone could wish for in Cyclocross. Friction is reduced to a minimum and shifting precision is assured even in the presence of mud. The single axle of the Power Torque System™ assures absolute stiffness and quick assembly and servicing.

## CAMPAGNOLO® EXCLUSIVE TECHNOLOGIES:

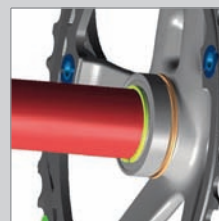

### SPECIALLY-DESIGNED DOUBLE-LIP SEAL FOR CX:

ensures that the mechanical parts (balls/bearings) subjected to the extreme conditions of Cyclocross stay clean, smooth-running and durable.



### CARBON FIBRE CRANKS:

light weight and high stiffness to torsion and flexion – enable efficient power transmission.

### GIRO® CYCLOCROSS ADVANCED RACING TECHNOLOGY™



### C.A.R.T. - CYCLOCROSS ADVANCED RACING TECHNOLOGY™:

chainrings for Campagnolo® 11-speed groupsets developed specifically for Cyclocross use – efficiency in all conditions of use.



### CHAIN UP SHIFT AND DOWNSHIFT ZONES SPECIALLY DESIGNED FOR CYCLOCROSS:

fast shifting even in critical situations due to rough terrain or the presence of mud on the chainrings.

### POWER TORQUE SYSTEM™



### POWER TORQUE SYSTEM™ BOTTOM BRACKET WITH SPECIAL SEALS FOR CYCLOCROSS:

reduced U-factor and Q-factor – durability over time even in extreme use and in difficult conditions.

## FEATURES & BENEFITS

- **Black anodised finish on the chainrings:** greater protection of the exposed parts and aesthetics in line with the carbon fibre crank
- **Combinations: 50-34 and 46-36:** developed and optimised for Cyclocross



## CAMPAGNOLO® EXCLUSIVE TECHNOLOGIES:

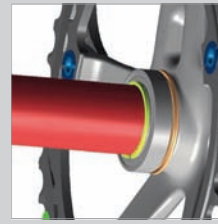

### SPECIALLY-DESIGNED DOUBLE-LIP SEAL FOR CX:

ensures that the mechanical parts (balls/bearings) subjected to the extreme conditions of Cyclocross stay clean, smooth-running and durable.

### C.A.R.T. - CYCLOCROSS ADVANCED RACING TECHNOLOGY™



**C.A.R.T. - CYCLOCROSS ADVANCED RACING TECHNOLOGY™:** chainrings for Campagnolo® 11-speed groupsets developed specifically for Cyclocross use – efficiency in all conditions of use.

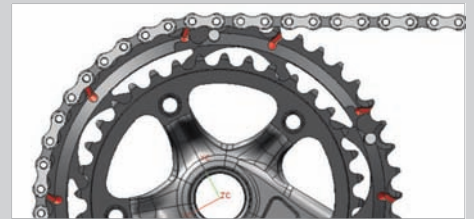

**CHAIN UP SHIFT AND DOWNSHIFT ZONES SPECIALLY DESIGNED FOR CYCLOCROSS:** fast shifting even in critical situations due to rough terrain or the presence of mud on the chainrings.

### POWER TORQUE SYSTEM™



**POWER TORQUE SYSTEM™ BOTTOM BRACKET WITH SPECIAL SEALS FOR CYCLOCROSS:** reduced U-factor and Q-factor – durability over time even in extreme use and in difficult conditions.

## FEATURES & BENEFITS

- **Combinations: 50-34 and 46-36:** developed and optimised for Cyclocross



728 g

## CX 11 CRANKSET POWER TORQUE SYSTEM™

Campagnolo® has optimised the chainrings to assure shifting without hesitation even in extreme conditions.

The 11s crankset in aluminium, “transformed” for CX use, is now ready to confront the challenging courses with mud, sand, and water!

The new bottom bracket Power Torque System™ assures the same U-factor and Q-factor values, extremely important in Cyclocross, while the chainring combination offers the two classic options for this sport: 50-34 or 46-36.

The special graphics distinguish the crankset of the Cyclocross series.



138 g



## CX CANTILEVER BRAKES

Campagnolo® has a strong belief in cyclocross and to prove this it will offer, starting from 2012, an exhaustive range dedicated to the toughest discipline of the two-wheel world.

The cantilever brakes, offered in a silver or black version, have been designed to the smallest detail: optimisation of the gear levers for top braking and modularity, corrosion-resistant materials, optimisation of the design to avoid mud deposits and adjustments to the brake pads for maximum braking performance.

Together with the dedicated crank sets and wheels, you now have everything you need to face the toughest situations and the many hidden challenges of cyclocross.

## CAMPAGNOLO® EXCLUSIVE TECHNOLOGIES:



### OPTIMISED DESIGN FOR CYCLOCROSS:

prevents the accumulation of mud or other material between the brake and wheel – maintains performance even on the most challenging of terrains.



### POSSIBILITY OF ADJUSTING THE BRAKE PADS AND THE TENSION OF THE CABLES:

allows you to adjust the brake pads in the best position with respect to the braking track.



### POSSIBILITY OF ADJUSTING THE DISTANCE BETWEEN THE BRAKING PADS AND THE RIM:

allows adjusting the distance between the braking pads and the rim according to your needs.







## KHAMPSIN™ CX

Clincher

1873 grams for the new Khamsin™ CX version: for Campagnolo® it represents the entry level, for many, a starting point. In fact, Khamsin™ CX represents the real point of reference for wheels in this segment: the absolute winner in terms of price/quality ratio.

## WHEEL TECH

### RIM



#### **SPOKE DYNAMIC BALANCE™:**

the balancing spoke assures the maximum wheel stability even at high speeds.

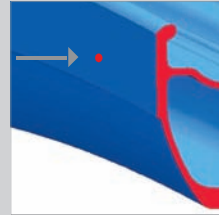

#### **WEAR INDICATOR:**

allows you to check the state of wear and tear on the rim instantaneously.

#### **MAXIMUM COMPATIBILITY:**

the profile of the rim can hold up to 35mm clinchers.

### SPOKES



#### **STRAIGHT-HEAD SPOKES:**

maximum stiffness of the wheel – maintains the spoke tension and long-lasting performance.



#### **EXCLUSIVE G3™ SPOKE PATTERN:**

perfect balance of the spoke tensions on both sides of the wheel. Reduces stress, increases transversal rigidity and the transmission of power to the wheel. G3™ eliminates vibrations even with “heavy” cyclists.

### HUB

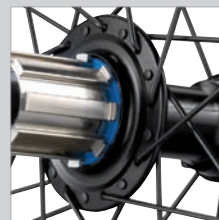

#### **OVERSIZED FLANGE:**

increases the torsional stiffness, increasing reactivity at each change of pace of the cyclist.





# KHAMHSIN<sup>®</sup> CX

Clincher



**ALUMINIUM HUB BODY:**  
provides a high degree of lateral stiffness.

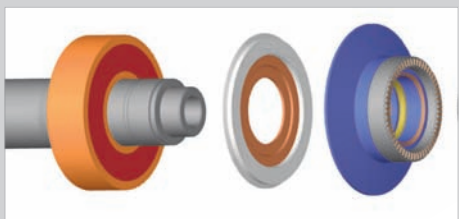

**ADDITIONAL SEAL:**  
keeps the bearings/balls zone clean and smooth running, maintaining performance over time.

**SEALED BEARINGS:**  
maintains performance over time – longer life of the balls/bearings.

## QUICK RELEASE



**STEEL SPINE AND ECCENTRIC, ALUMINUM LEVER AND DIE.**  
Eccentric-closure system allows cyclist to modulate the pressure necessary for heightened sensitivity to find the proper closure for the block. Easy to use, with a material resistant to wear and tear, rust, and pressure.



1873 g



## S.H.A.R.C.

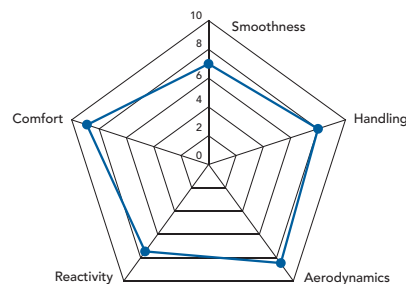
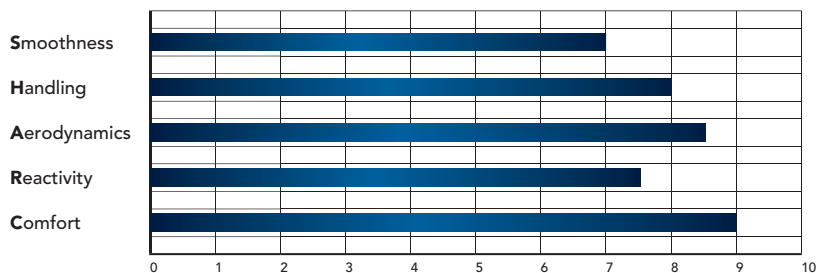



## VENTO™ REACTION™ CX

### Clincher

The characteristic G3™ spoke pattern on the front and rear and the oversize flanges will make this an unmistakable wheel, now created in a special version for racing on the muddy terrains of the Cyclocross course.

Thanks to the technical aspects developed by the Campy Tech Lab™ specifically for CX, Vento™ Reaction™ wheels are bound to give you the utmost satisfaction.

## WHEEL TECH

### RIM



#### **SPOKE DYNAMIC BALANCE™:**

the balancing spoke assures the maximum wheel stability even at high speeds.

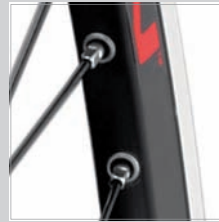

#### **RIM WITH EYELETS:**

correct nipple/spoke alignment – reduces the noise level, reinforces the spoke seats.

#### **MAXIMUM COMPATIBILITY:**

the profile of the rim can hold up to 35mm clinchers.

### SPOKES

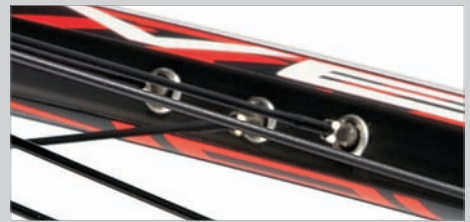

#### **EXCLUSIVE G3™ SPOKE PATTERN:**

perfect balance of the spoke tensions on both sides of the wheel. Reduces stress, increases transversal rigidity and the transmission of power to the wheel. G3™ eliminates vibrations even with “heavy” cyclists.

**STEEL SPOKES WITH VARIABLE THICKNESS:** maximum aerodynamic penetration and stability at high speeds.

### HUB



#### **ALUMINIUM HUB BODY:**

provides a high degree of lateral stiffness.



# VENTO REACTION EX

## Clincher



**OVERSIZED FLANGE:** increases the torsional stiffness, increasing reactivity at each change of pace of the cyclist.

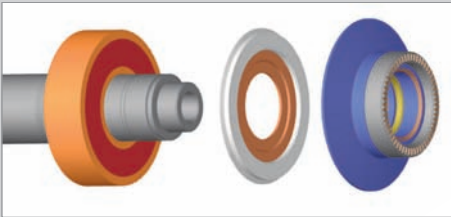

**ADDITIONAL SEAL:** keeps the bearings/balls zone clean and smooth running, maintaining performance over time.

**SEALED BEARINGS:** maintains performance over time – longer life of the balls/bearings.

### QUICK RELEASE



**STEEL SPINE AND ECCENTRIC, ALUMINUM LEVER AND DIE.** Eccentric-closure system allows cyclist to modulate the pressure necessary for heightened sensitivity to find the proper closure for the block. Easy to use, with a material resistant to wear and tear, rust, and pressure.



1827 g



### S.H.A.R.C.

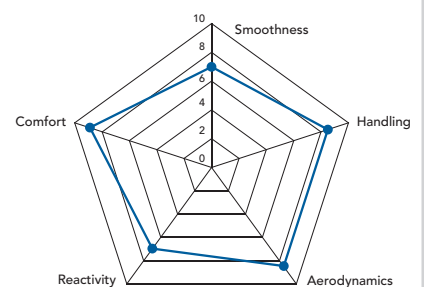
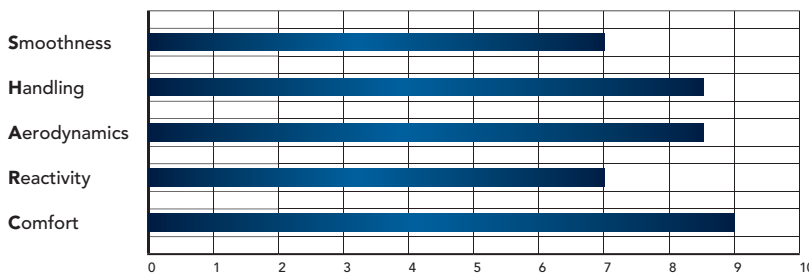



## SCIROCCO™ CX

### Clincher

Scirocco™ continues to be a huge success in the traditional "road" configuration. Its eclectic characteristics were the perfect starting point for producing a Cyclocross product destined to become a point of reference.

## WHEEL TECH

### RIM



#### **SPOKE DYNAMIC BALANCE™:**

the balancing spoke assures the maximum wheel stability even at high speeds.



#### **RIM WITH EYELETS:**

correct nipple/spoke alignment – reduces the noise level, reinforces the spoke seats.

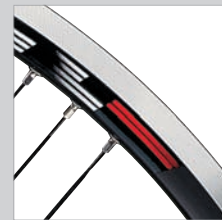

#### **MACHINED SIDES:**

reduces the peripheral weight of the rim.

**MAXIMUM COMPATIBILITY:** the profile of the rim can hold up to 35mm clinchers.

### SPOKES



#### **EXCLUSIVE G3™ SPOKE PATTERN:**

perfect balance of the spoke tensions on both sides of the wheel. Reduces stress, increases transversal rigidity and the transmission of power to the wheel. G3™ eliminates vibrations even with "heavy" cyclists.

**STEEL SPOKES WITH VARIABLE THICKNESS:** maximum aerodynamic penetration and stability at high speeds.

**STRAIGHT-HEAD SPOKES:** maximum stiffness of the wheel – maintains the spoke tension and long-lasting performance.



# SCIROCCO EX

## Clincher

### HUB



**ALUMINIUM HUB BODY:** provides a high degree of lateral stiffness.

**OVERSIZED FLANGE:** increases the torsional stiffness, increasing reactivity at each change of pace of the cyclist.

**SEALED BEARINGS:** maintains performance over time – longer life of the balls/bearings.

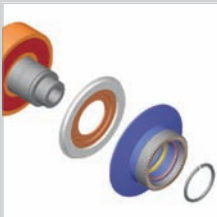

**ADDITIONAL SEAL:** keeps the bearings/balls zone clean and smooth running, maintaining performance over time.

### QUICK RELEASE



**NEW, COMPLETELY REDESIGNED AND LIGHTER WHEEL BLOCK STEEL SPINE AND ECCENTRIC, LEVER WITH DRILL LIGHTENING AND ALUMINUM DIE.**

Eccentric-closure system allows cyclist to modulate the pressure necessary for heightened sensitivity to find the proper closure for the block. Easy to use, with a material resistant to wear and tear, rust, and pressure.



1795 g



### S.H.A.R.C.

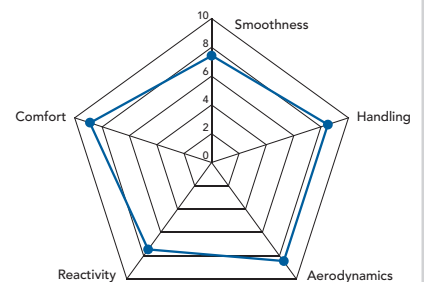
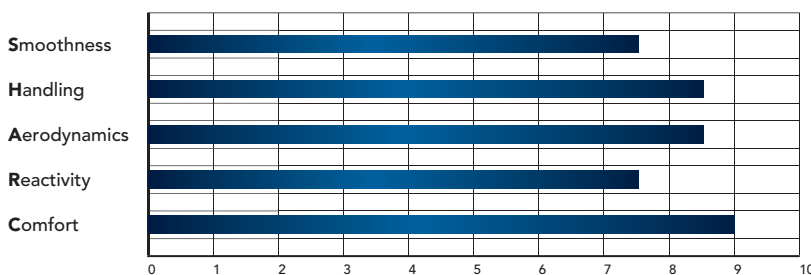



## BULLET™ ULTRA™ CX

### Clincher

Nothing can stop a Bullet™. Not even the mud, the rain or the sand of challenging cyclocross tracks.

Just when conditions become extreme, Bullet™ CX are elated and bring out their gritty and successful character.

Lightness, smoothness and responsiveness: the high-profile aluminium and carbon fibre wheels for cyclocross riders who don't just want to participate, but want to get on the top step of the podium.

## WHEEL TECH

### RIM

#### ALUMINIUM PROFILE FOR CLINCHERS:

it allows the use of the traditional clincher up to 35mm.

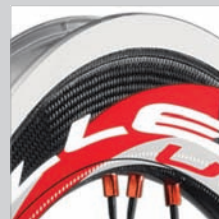

#### INTEGRATED ALUMINIUM/CARBON RIM STRUCTURE:

the exclusive coupling system of the aluminium rim and carbon structure makes the rim extremely rigid, it allows for excellent responsiveness levels and durability of the wheel.

#### DYNAMIC BALANCING ON THE RIM:

thanks to a special operation of the production process, the carbon fiber layup is positioned in such a way as to obtain perfect balancing of the rim even at high speeds.

#### MOMAG™:

allows the external profile of the rim to be free of holes – increases structural resistance – makes rim tape unnecessary and reduces the weight of the wheel.

#### EXCLUSIVE PRESSING SYSTEM FOR THE RIM IN UNPAINTED CARBON:

enables an extremely limited weight and a smooth surface free from imperfections.

### SPOKES

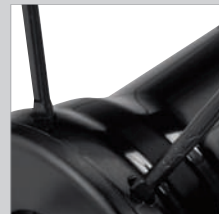

#### SPOKES ANTI-ROTATION SYSTEM™:

keeps the spokes in the position of maximum aerodynamic penetration.

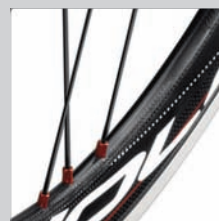

#### EXCLUSIVE G3™ SPOKE PATTERN:

perfect balance of the spoke tensions on both sides of the wheel. Reduces stress, increases transversal rigidity and the transmission of power to the wheel. G3™ eliminates vibrations even with "heavy" cyclists.

#### DRSC™ (DIRECTIONAL RIM-SPOKE COUPLING):

exclusive rim/spoke coupling system. It allows the rim, spokes, nipples and hub to align properly with the same tensioning value in all areas.

**AERODYNAMIC PROFILE IN STEEL:** ensuring the maximum aerodynamic penetration and, thanks to the material employed, lower weight and greater reactivity.

#### SELF-LOCKING OVERSIZE ALUMINIUM NIPPLES:

they reduce the peripheral mass of the wheel to a minimum, thus increasing responsiveness. The nipples' self-locking system provides the correct tension of the spokes and does not require any maintenance.



Clincher

**HUB**



**ADDITIONAL SEAL:** keeps the bearings /balls zone clean and smooth running, maintaining performance over time.

**CUP AND CONE BEARINGS:** easy ball/bearing adjustment – reduces possible ball/bearing play – precision operation – maintains performance over time.



**ALUMINIUM HUB BODY:** gives the wheel a high degree of lateral stiffness and reduces weight to the minimum.

**OVERSIZED FLANGE ON THE DRIVE SIDE:** increases the torsional stiffness, increasing reactivity at each change in rhythm of the pedal stroke.

**ALUMINIUM AXLE:** it reduces the weight of the wheel.

**QUICK RELEASE**



**NEW, COMPLETELY REDESIGNED AND LIGHTER AERODYNAMIC-PROFILE WHEEL BLOCK. STEEL SPINE AND ECCENTRIC, LEVER WITH DRILL LIGHTENING AND ALUMINIUM DIE.**



1610 g



**S.H.A.R.C.**

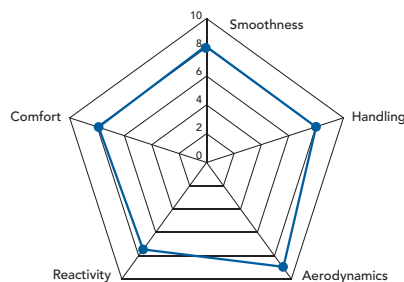
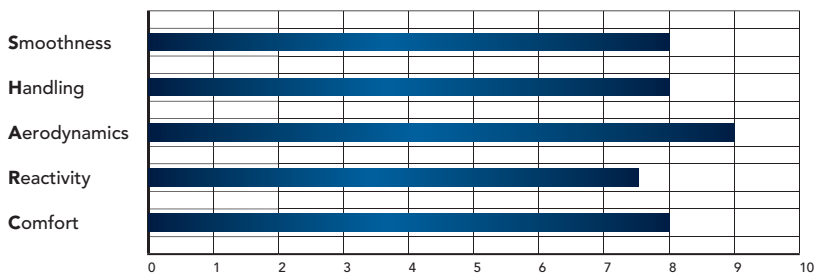



## BORA™ ONE CX

### Tubular

Flying across mud, water and sand.

Lighter wheels used to succeed have a clear name: Bora™ One CX. Derived directly from the road version, the "CX" have a special double lip seal innovation in the hub that keeps the balls/bearings area clean, thus maintaining the performance of the wheel in terms of smoothness and durability.

Tubular with a full carbon rim, the wheel that at just 1350g has a specific goal: the highest step of the podium.

## WHEEL TECH

### RIM



#### **FULL CARBON HIGH PROFILE FOR 50mm TUBULAR:**

provides the maximum aerodynamic penetration. Extremely limited weight. The highest degree of lateral stiffness and reactivity of the wheel.

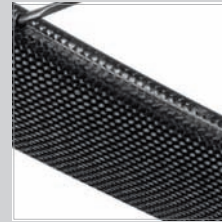

#### **EXCLUSIVE RIM PRINTING SYSTEM:**

rim painting no longer required. The weight is greatly reduced and the surface is free from imperfections.

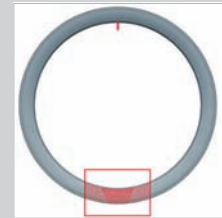

#### **RDB™ RIM DYNAMIC BALANCE:**

exclusive system that assures perfect balancing of the rim even at high speeds. Moulded into the rim itself.



#### **NEW BRAKE PADS MADE ESPECIALLY FOR CARBON WHEELS:**

the new blend increases the brake performance on both wet and dry surfaces without increasing the wear and tear on the pad. For a more modular and more secure stop.

### SPOKES

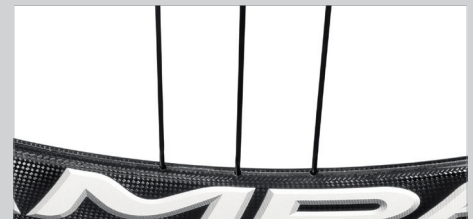

**EXCLUSIVE G3™ SPOKE PATTERN:** perfect balance of the spoke tensions on both sides of the wheel. Reduces stress, increases transversal rigidity and the transmission of power to the wheel. G3™ eliminates vibrations even with "heavy" cyclists.

#### **SPOKES WITH AERODYNAMIC PROFILE:**

provides the maximum aerodynamic penetration. Reduces aerodynamic drag saving rider energy.

**SPOKES ANTI-ROTATION SYSTEM:** allows the spokes to maintain the best aerodynamic position.



Tubular

**HUB**

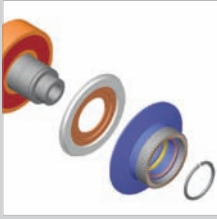

**ADDITIONAL SEAL:** keeps the bearings /balls zone clean and smooth running, maintaining performance over time.



**ALUMINIUM HUB:** provides a high degree of lateral stiffness and reduces weight to the minimum.

**OVERSIZED FLANGE:** increases the torsional stiffness, increasing reactivity at each change of pace of the cyclist.

**CUP AND CONE BEARINGS:** easy ball/bearing adjustment  
 – reduces possible ball/bearing play – precision operation  
 – maintains performance over time.

**ALUMINIUM AXLE:** reduces the weight of the wheel.

**QUICK RELEASE**



**NEW, COMPLETELY REDESIGNED AND LIGHTER WHEEL BLOCK STEEL SPINE AND ECCENTRIC, LEVER WITH DRILL LIGHTENING AND ALUMINIUM DIE.**



1350 g



**S.H.A.R.C.**

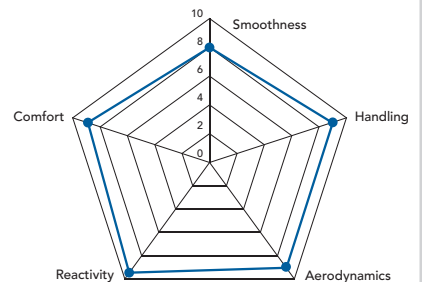
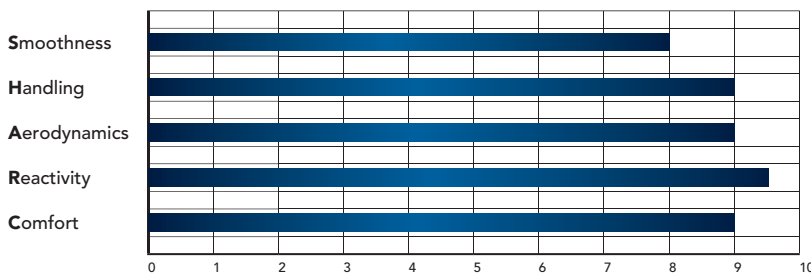



## RECORD™ PISTA™ GROUPSET

The Record™ Pista™ groupset is a set of high-range components designed to excel in the velodrome.

It includes the crankset, hubs and bottom bracket. Three products designed exclusively for the specific needs of use on the track.

The other components, such as seat posts, pedals and headsets have been borrowed directly from the Record™ road groupset.



**WHEEL TECH****RIM**

**38mm ALUMINIUM AERO RIM:**  
maximum lateral and torsional  
stiffness – maintains stiffness  
features over time.

**SPOKES**

**STAINLESS STEEL AERO SPOKES:**  
maximum stiffness maintained over  
time.

**2035 g****PISTA™****Tubular**

A noble and fascinating specialty with an exclusively specific feature: the transformation of the explosive power of the quadriceps of top track cyclists into pure speed, with the minimum possible waste of energy. Designed to maximize the rigidity and resistance to bending and torsional radial strength, the Pista™ wheel has aluminium 38mm rim and stainless steel spokes to provide better reaction and power.





